

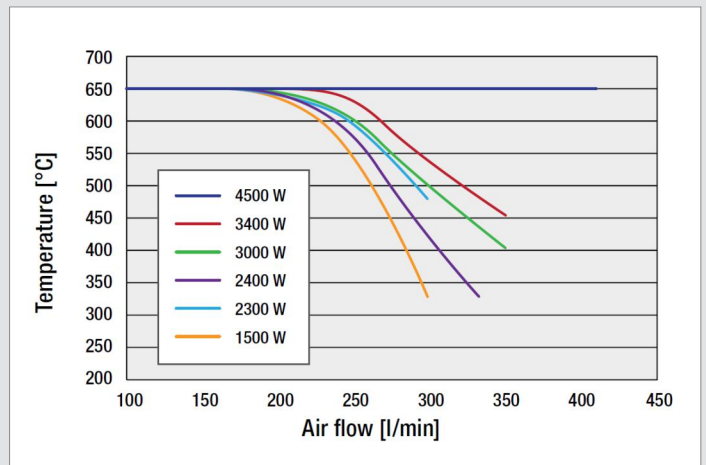

MISTRAL 6 SYSTEM Hot Air Blower

The MISTRAL 6 SYSTEM offers closed-loop temperature control thanks to its integrated thermocouple and control system. Its brushless blower motor makes it perfectly suited to applications with continuous operation requirements.

- Temperature adjustable up to 650°C
- Brushless blower motor for continuous operation
- Air volume and temperature independently adjustable
- Automatic cool down function
- Remote control interface
- Integrated thermocouple for closed-loop temperature control
- Display shows target and actual values
- Light weight and compact design
- Heater tube designed for even airflow
- Automatic tool and heating element protection
- Air hose connection includes internal 1-inch thread
- Wide range of nozzles & accessories available for use



Technical Data

	V	120	230	230	230
Voltage	V	120	230	230	230
Power consumption	W	2400	2300	3400	4500
Max. air flow	l/min	350	300	350	400
Max. air pressure	kPa	3.5	2.5	2.5	3.0
Max. temperature	°C	650	650	650	650
Noise level	dB	65	65	65	65
Heater tube	mm	Ø 50	Ø 36.5	Ø 50	Ø 50
Size (L x W x H)	mm	317 x 90 x 91			
Weight	kg	1.4	1.2	1.4	1.5
Approval markings		CE, cURus	CE, cURus	CE, cURus	CE, cURus
Electrical protection		Class II	Class II	Class II	Class II







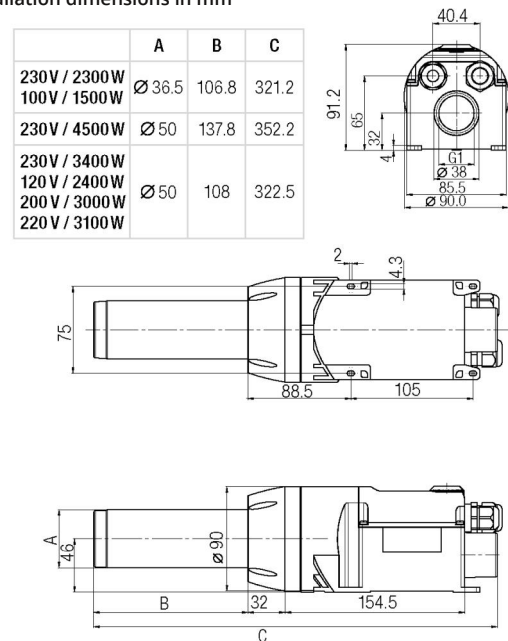





















Article No.:

147.969: MISTRAL 6 SYSTEM 120V / 2.4kW
 147.975: MISTRAL 6 SYSTEM 230V / 2.3kW
 146.701: MISTRAL 6 SYSTEM 230V / 3.4kW
 147.968: MISTRAL 6 SYSTEM 230V / 4.5kW























Installation dimensions in mm



MISTRAL 120V; 230V 3.6kW, 4.5kW Accessories

					
122.332: Nozzle adapter Ø50 mm to Ø62 mm	122.924: Ø50 mm to Ø36.5 mm	107.330: Folding reflector Ø125 x 22mm	107.331: Folding reflector Ø72 x 70 mm	106.127: Sieve reflector Ø65 mm	107.327: Sieve reflector 75 x 70 x 90 mm
					
107.333: Sieve reflector 150 x 110 x 137 mm	107.340: Shell reflector 250 x 45 x 58 mm	149.943: Round nozzle Ø30 mm outlet	105.961: Wide slot nozzle 42 x 11 mm	107.258: Wide slot nozzle 70 x 10 mm	106.057: Wide slot nozzle 100 x 4 mm
					
106.060: Wide slot nozzle 150 x 6 mm	107.270: Wide slot nozzle 150 x 12 mm	106.061: Wide slot nozzle 300 x 6 mm	107.254: Flange connector Ø50 mm to Ø70 mm	107.255: Tubular nozzle Ø35 mm, 160 mm	105.952: Tubular nozzle Ø50 mm with slot 800 x 0.9 mm
					
105.955: Tubular nozzle Ø50 mm with slot 660 x 1 mm	105.950: Tubular nozzle Ø50 mm with slot 300 x 2 mm	107.257: Tubular nozzle Ø50 with slot 420 x 1.8 mm	107.256: Tubular nozzle Ø48 mm, 73 x 170 mm	153.245: Stainless steel filter	107.286: Air hose Ø38 mm, PVC
					
107.287: Hose clip Ø38/60 mm	106.956: Thermocouple type K, Ø1.5 x 160 mm, with plug	106.958: Thermocouple extension cable type K, 2 m	106.960: Thermocouple extension cable type K, 4 m	106.962: Thermocouple extension cable type K, 10 m	

MISTRAL 230V 2.3kW Accessories

					
125.316: Flange connector Ø36.5 mm to Ø62 mm	149.942: Round nozzle Ø22 mm outlet	105.435: Wide slot nozzle 20 x 2 mm	107.261: Wide slot nozzle 70 x 4 mm	108.078: Wide slot nozzle 100 x 4 mm	105.982: Wide slot nozzle 150 x 4 mm
					
105.454: Tubular nozzle Ø9 mm, 50 mm	107.003: Tubular nozzle Ø12 mm, 25 x 50 mm, without clamps	107.002: Tubular nozzle Ø12 mm, 25 x 50 mm, with clamps	105.446: Tubular nozzle Ø25 mm, 25 x 95 mm	107.251: Tubular nozzle Ø35 mm, 210 mm	106.132: Shell reflector 150 x 26 x 44 mm
					
107.308: Sieve reflector 50 x 34 mm	107.309: Sieve reflector 35 x 20 mm	107.314: Spoon reflector 33 x 27 mm	107.319: Sieve reflector Ø65 mm	153.245: Stainless steel filter	107.286: Air hose Ø38 mm, PVC
					
107.287: Hose clip Ø38/60 mm	106.956: Thermocouple type K, Ø1.5 x 160 mm, with plug	106.958: Thermocouple extension cable type K, 2 m	106.960: Thermocouple extension cable type K, 4 m	106.962: Thermocouple extension cable type K, 10 m	