

LEISTER®

DE EN IT FR ES PT

**MISTRAL
PREMIUM**



**MISTRAL
SYSTEM**



Leister Technologies AG
Galileo-Strasse 10
CH-6056 Kaegiswil/Switzerland

Tel. +41 41 662 74 74
Fax +41 41 662 74 16

www.leister.com
sales@leister.com

Size	3
Wiring Diagram	4, 5, 6

DE	Deutsch	Bedienungsanleitung	7
EN	English	Operating Instructions	21
IT	Italiano	Istruzioni per l'uso	35
FR	Français	Notice d'utilisation	49
ES	Español	Instrucciones de funcionamiento	63
PT	Português	Manual de instruções	77

Size mm MISTRAL PREMIUM; SYSTEM

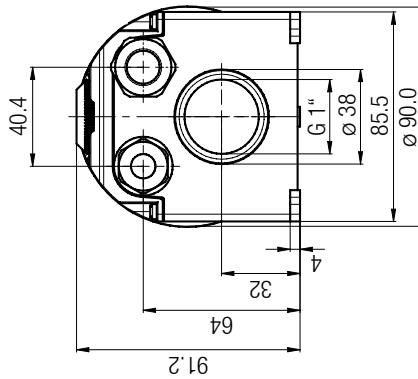
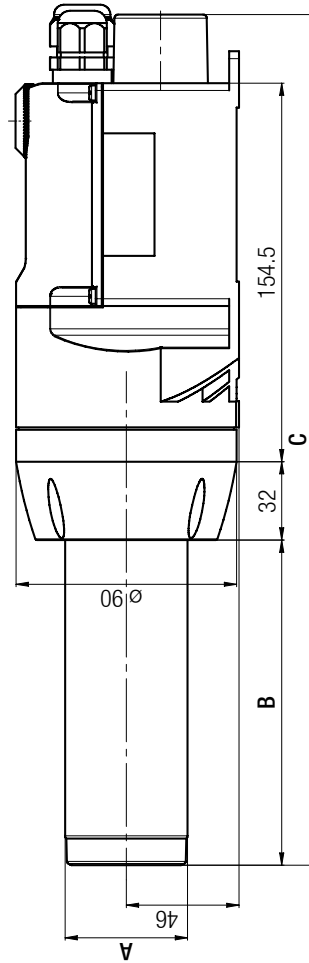
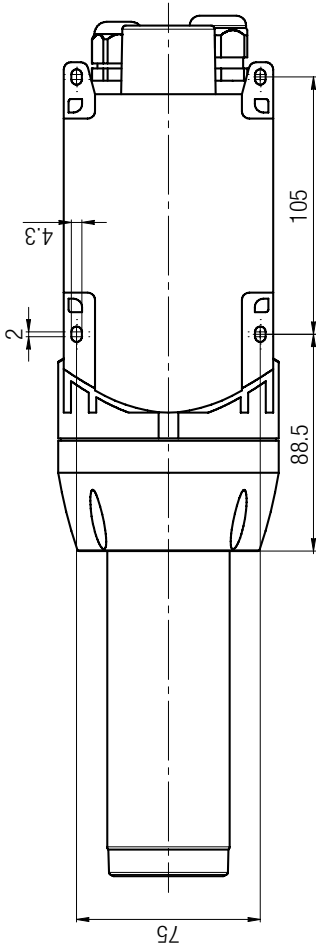

	A	B	C
230V / 2300W 100V / 1500W	$\varnothing 36.5$	106.8	321.2
230V / 4500W	$\varnothing 50$	137.8	352.2
230V / 3400W 120V / 2400W 200V / 3000W 220V / 3100W	$\varnothing 50$	108	322.5

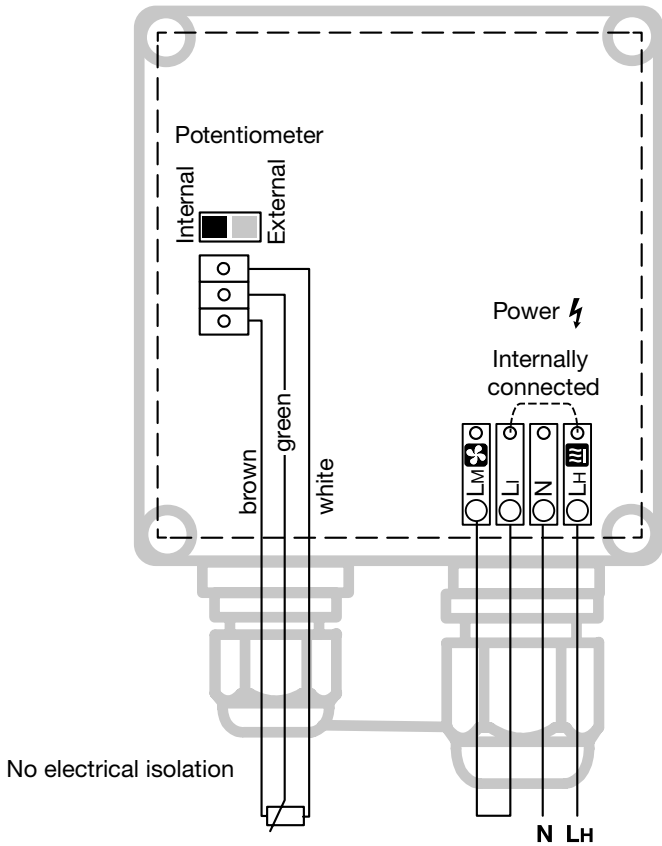
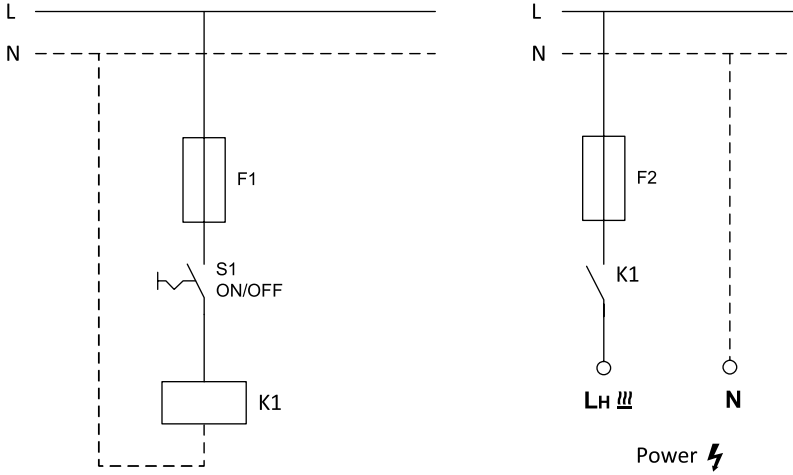

Wiring diagram MISTRAL PREMIUM: Heating, Blower separated

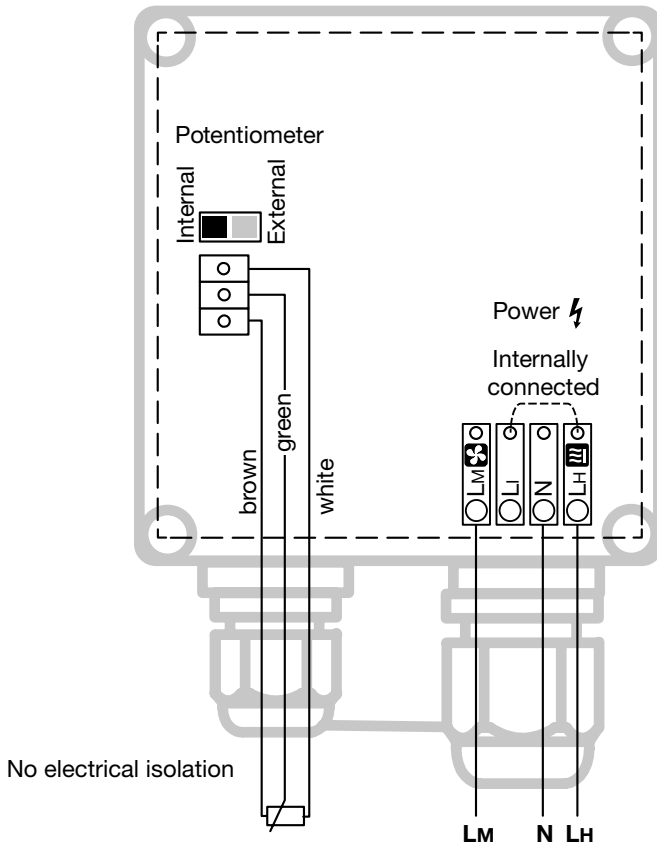
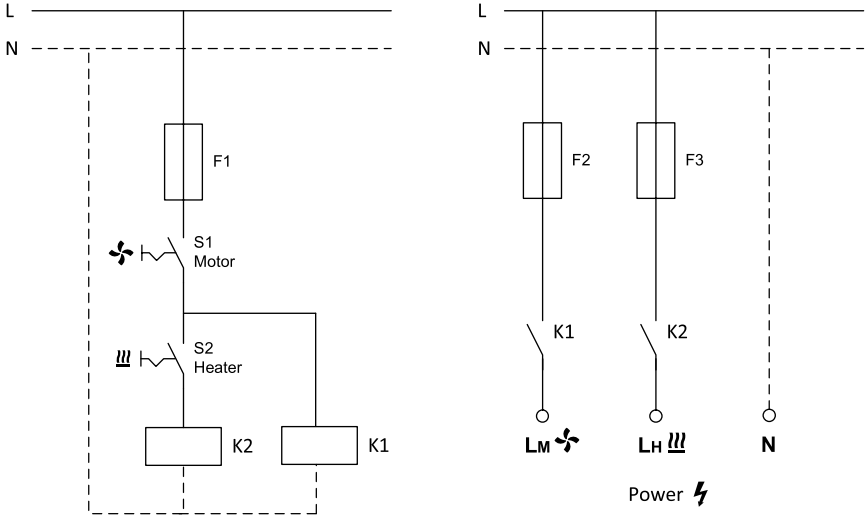

Wiring diagram MISTRAL SYSTEM

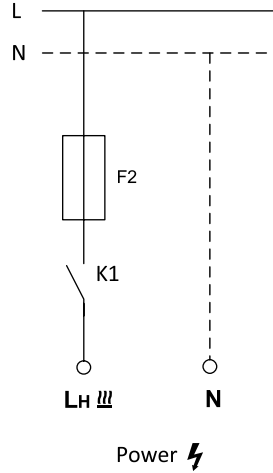
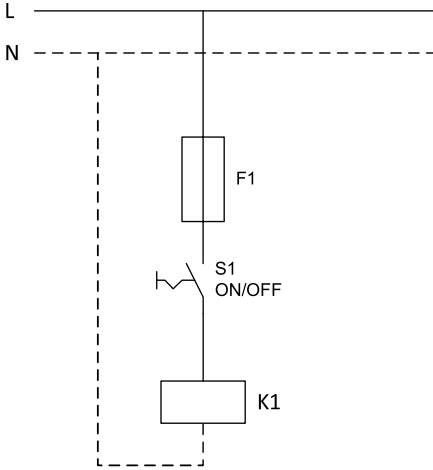

Input 0 – 10V

Input 4 – 20 mA

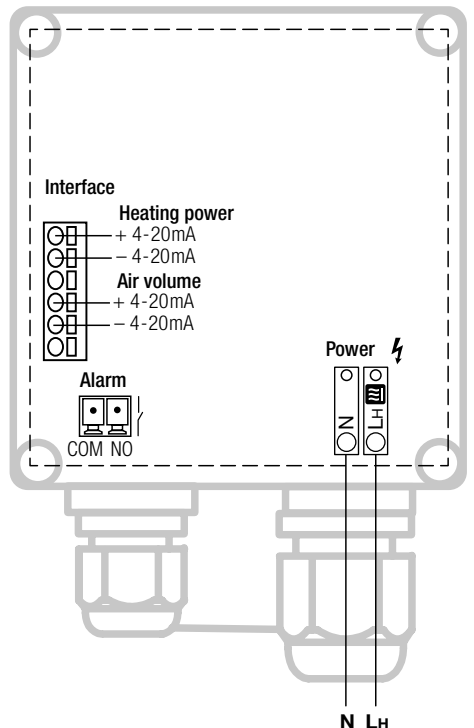
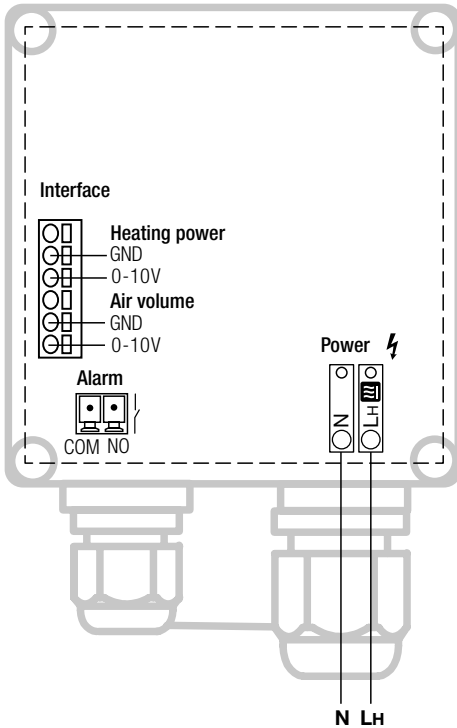



Bedienungsanleitung vor Inbetriebnahme aufmerksam lesen und zur weiteren Verfügung aufbewahren.

Heissluft-Gebläse MISTRAL PREMIUM; SYSTEM

Anwendung

Das Heissluft-Gebläse MISTRAL eignet sich für den Einbau in Maschinen, Anlagen oder Geräten.

Seine wichtigsten Anwendungen sind zum Beispiel Trocknen und Aufheizen, Auftauen, Beschleunigen und Auflösen, Sterilisieren, Glätten, Glänzen, Aktivieren und Lösen, Trennen und Verschmelzen, Schrumpfen, Entfernen.



Warnung



Lebensgefahr beim Öffnen des Gerätes, da spannungsführende Komponenten und Anschlüsse freigelegt werden. Vor dem Öffnen des Gerätes muss dieses allpolig vom Netz getrennt werden.



Feuer- und Explosionsgefahr bei unsachgemäßem Gebrauch von Heissluftgeräten, besonders in der Nähe von brennbaren Materialien und explosiven Gasen. Innen liegende Decken, Böden, Laibungsbretter, Wände und andere Verkleidungen können entflammable Materialien enthalten, die bei der Arbeit durch das Heissluftgerät entzündet werden könnten. Die Entzündung dieser Materialien ist möglicherweise nicht sichtbar und könnte zu Sach- und Personenschäden führen.



Verbrennungsgefahr! Heizelementrohr und Düse nicht in heissem Zustand berühren. Gerät abkühlen lassen. Heissluftstrahl nicht auf Personen oder Tiere richten.



Vorsicht



Nennspannung, die auf dem Gerät angegeben ist, muss mit der Netzspannung übereinstimmen. Maximale Netzimpedanz $0.180 \Omega + j 0.113 \Omega$, gemäss EN 61000-3-11/UL 499/CSA C22.2 No 88. Im Zweifelsfall ist das zuständige Elektrizitäts-Versorgungs-Unternehmen zu konsultieren.



Gerät **muss beobachtet** betrieben werden. Wärme kann zu brennbaren Materialien gelangen, die sich ausser Sichtweite befinden. Gerät darf nur von **ausgebildeten Fachleuten** oder unter deren Aufsicht benützt werden. Kindern ist die Benützung gänzlich untersagt.











Ausschliesslich zum Gebrauch in Innenräumen.









Entsorgung



Elektrogeräte, Zubehör und Verpackungen sollen einer umweltgerechten Wiederverwertung zugeführt werden. Bitte berücksichtigen Sie bei der Entsorgung unserer Produkte die nationalen und lokalen Vorschriften. **Für EU-Länder:** Bitte werfen Sie Elektrogeräte nicht in den Hausmüll.

Technische Daten MISTRAL

MISTRAL 2, 4, 6 PREMIUM		2	4	6	6	6	6	6
Spannung	V~	230	120	120	230	230	230	220
Leistung	W	3400	2400	2400	2300	3400	4500	3100
Strom	A	15	20	20	10	15	20	14
Frequenz	Hz	50 / 60						60
Max. Luftaustrittstemperatur, offen	°C	520	490	430	500	510	650	510
Max. Lufteintrittstemperatur	°C	60						
Max. Umgebungstemperatur	°C	65						
Max. Luftmenge (20 °C Umgebung)	l/min.	350	300	350	300	350	400	350
Max. Statischer Druck	kPa	3.5	3.5	2.5	2.5	2.5	3.0	2.5
Emissionspegel	L _{pA} (dB)	65						
Gewicht	kg	1.4	1.4	1.4	1.2	1.4	1.5	1.4
Schnittstelle (nicht potentialfrei)		Externes Potentiometer für Heizleistung						
Masse (Size)		Seite 3						
Konformitätszeichen								
Sicherheitszeichen			  				 	
Schutzklasse II								

MISTRAL 6 SYSTEM		6						
Spannung	V~	100	120	200	230	230	230	220
Leistung	W	1500	2400	3000	2300	3400	4500	3100
Strom	A	15	20	15	10	15	20	14
Frequenz	Hz	50 / 60						60
Max. Luftaustrittstemperatur, offen	°C	650						
Max. Lufteintrittstemperatur	°C	60						
Max. Umgebungstemperatur	°C	65						
Min. Luftmenge (Luftsollwert 1 %)	l/min.	100	100	100	100	100	100	100
Max. Luftmenge (Luftsollwert 100 %)	l/min.	300	350	350	300	350	400	350
Max. Statischer Druck	kPa	3.5	3.5	3.5	3.5	3.5	3.5	3.5
Emissionspegel	L _{pA} (dB)	65						
Gewicht	kg	1.2	1.4	1.4	1.2	1.4	1.5	1.4
Schnittstelle (potentialfrei)		4-20mA und 0-10V für Heizleistung & Luftmenge Alarmausgang						
Masse (Size)		Seite 3						
Konformitätszeichen								
Sicherheitszeichen			  				 	
Schutzklasse II								

Technische Änderungen vorbehalten

Technische Daten Gerätefunktion

MISTRAL	PREMIUM	SYSTEM
Integrierte Leistungselektronik	•	•
Schutz vor Heizelement- und Geräteüberhitzung	•	•
Integrierter Kodierschalter für Potentiometer (intern / extern)	•	
Heizleistung mit Potentiometer stufenlos einstellbar	•	
Heizleistung getrennt schaltbar für Cool Down- Funktion	•	
Display zur Anzeige der Soll- oder Ist-Werte (°C oder °F)		•
Temperatur und Luftmenge mit e-Drive stufenlos einstellbar		•
Integrierte Temperatursonde		•
Alarmausgang (Relaiskontakt)		•
Automatische Cool Down-Funktion		•
Einstellbare Temperaturbegrenzung		•
Einstellbare Temperaturoffset		•
Fernsteuer- Schnittstelle für Temperatur- oder Leistungsvorgabe		•
Fernsteuer- Schnittstelle für Luftmengenvorgabe		•
3-stufige Regelparameter-Anpassung (offene, mittlere und kleine Düse)		•

Technische Daten Schnittstelle

PREMIUM	Externes Potentiometer	Isolation	Nicht potentialfrei
		Widerstand	10 – 100 kOhm
SYSTEM	Allgemein	Isolation IEC/EN 60747-5-2	AC 1414 Vpeak
		Verpolungsschutz	
		Nullpunkt Korrektur	
	Spannungseingänge	Spannung 0 – 10V	DC 0... 10V (Rippel < 0.07 V bei 5 °C Auflösung) (Rippel < 0.4 V bei 5 % Auflösung)
		Max. Eingangsspannung	DC 12V
		Nenn- Eingangswiderstand	33.7 kOhm
		Stromeingänge	Strom 4 – 20 mA (2-Leiter-Technik)
	Max. Eingangsstrom		DC 22 mA
	Nenn-Eingangswiderstand		159 Ohm
	Alarmausgang (Relaiskontakt)	Max. Spannungen	AC 250 V, DC 30 V
		Max. Ströme	AC 3 A, DC 3 A
		Max. Kontaktwiderstand	100 mOhm bei DC 24 V / 1 A
		Kontaktart	SPST-NO
Isolation Kontakt zu Spule		AC 4000V 1 min.	
Isolation Kontakt zu Kontakt		AC 1000V 1 min.	

Ausführungen

MISTRAL	2 PREMIUM	4 PREMIUM	6 PREMIUM	6 SYSTEM
Bürstenloser Motor			•	•
Bürstenmotor mit Kohlenwechsel		•		
Bürstenmotor	•			

Technische Daten Funktionen

PREMIUM	Int. oder Ext. Potentiometer	Heizleistung	Leistungs-Vorgabe 0...100 % / OFF
SYSTEM	e-Drive oder Schnittstelle	Temperatur (closed Loop)	Temperatur-Vorgabe OFF, 50...650 °C; 5 °C Auflösung
		Temperatur (open Loop)	Leistungs-Vorgabe OFF, 5...100%; 5 % Auflösung
		Luftmenge	Luftmengen-Vorgabe 1, 5...100%; 5 % Auflösung

MISTRAL SYSTEM Temperatur-/Luftmengen-Diagramm

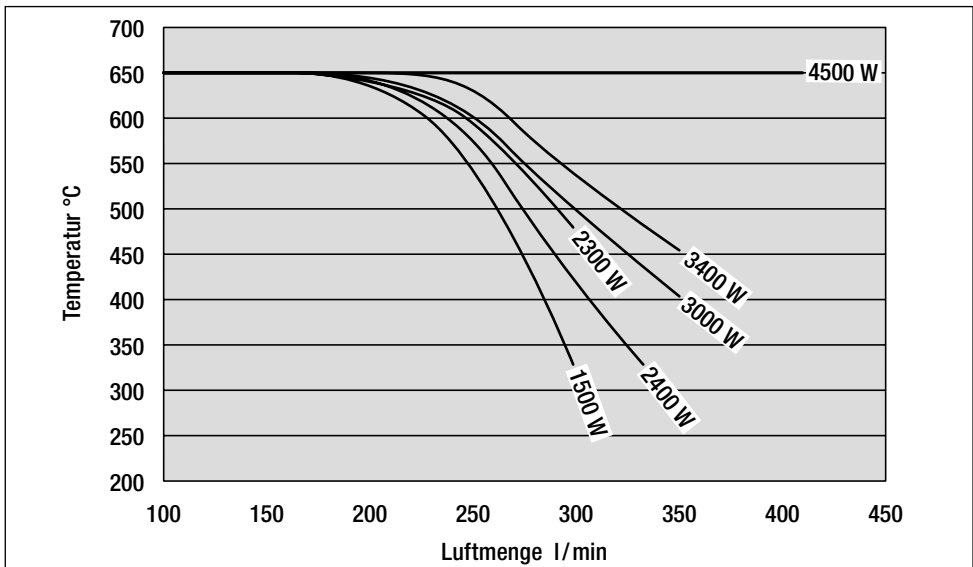

MISTRAL SYSTEM Schnittstelle / Ansteuerung

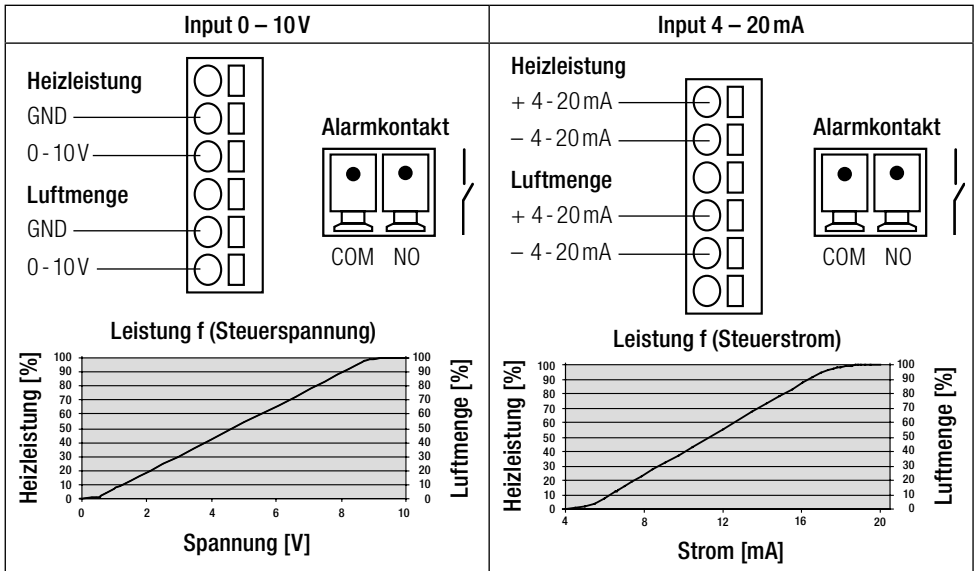

ACHTUNG:

Bei Verwendung als Einbaugerät muss im Netzanschluss eine geeignete Vorrichtung **zur allpoligen Trennung** vom Netz mit einem **Kontaktabstand von mindestens 3 mm** vorhanden sein.

Gerätebeschreibung MISTRAL PREMIUM; SYSTEM

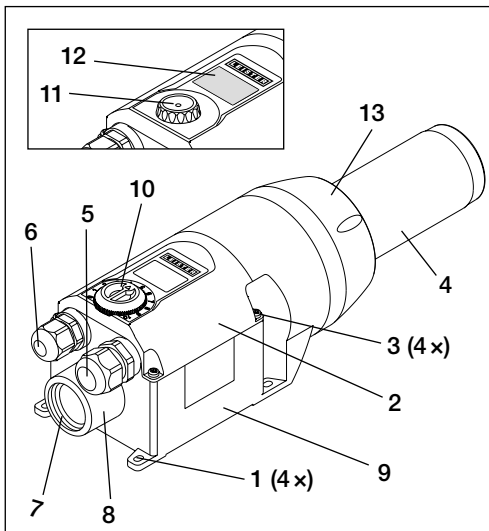

MISTRAL PREMIUM; SYSTEM

- 1 Montagelaschen
- 2 Abdeckung Anschlussgehäuse
- 3 Schrauben für Anschlussgehäuse
- 4 Heizelementrohr
- 5 Kabelverschraubung für Netzanschluss
- 6 Kabelverschraubung für Schnittstelle
- 7 Lufteinlassflansch mit Innengewinde G 1"
- 8 Anschluss \varnothing 38 für Luftschlauch oder Edelstahlfilter
- 9 Anschlussgehäuse
- 13 Befestigungsschrauben

MISTRAL PREMIUM

- 10 Potentiometer zur Einstellung der Heizleistung

MISTRAL SYSTEM

- 11 e-Drive für Temperatur-/ LuftEinstellung
- 12 Display

Vorbereitung MISTRAL PREMIUM; SYSTEM

- MISTRAL aus der Verpackung entnehmen.
- Durch Lösen der **Schrauben (3)** die **Abdeckung Anschlussgehäuse (2)** öffnen.
- **Kabelverschraubung für Netzanschluss (5)** lösen.
- Bei Bedarf die **Kabelverschraubung für Schnittstelle (6)** lösen.

Einbau

- Gerät darf nur von ausgebildeten Fachleuten eingebaut werden.
- Die Umgebungstemperatur darf nicht höher als 65 °C entsprechen
- Der Einbau muss gewährleisten, dass
 - nur kalte Luft zugeführt wird.
 - kein (Wärme-) Rückstau entsteht.
 - das Gerät nicht vom Heissluftstrahl eines anderen Gerätes angeströmt wird.
- MISTRAL vor mechanischen Vibrationen und Erschütterungen schützen.
- MISTRAL mit vier Schrauben Ø M4 an den **Montagelaschen (1)** befestigen.
- Senkrechte Positionierung des Geräts vermeiden. Falls eine senkrechte Position zwingend ist, Abkühlung des Geräts gewährleisten – **Überhitzungsgefahr.**
- Einbaumassee siehe Seite 3 (Size)
- Bei staubhaltiger Luft Leister-Edelstahlfilter (siehe Zubehör) verwenden und auf den **Anschluss ø 38 für Luftschlauch oder Edelstahlfilter (8)** schieben.
- Bei besonders kritischen Stäuben (z.B. Metall-, elektrisch leitende, oder feuchte Stäube) müssen spezielle Filter verwendet werden, um Kurzschlüsse im Gerät zu vermeiden.



Beim Einbau sind immer die lokal gültigen Normen und Richtlinien zu beachten (z. B. spezielle Brandschutzrichtlinien o. ä.).



Achtung: Gerät immer mit Luftversorgung betreiben!

Anschluss

- Der MISTRAL muss durch Fachpersonen angeschlossen werden.
- Im Netzanschluss muss eine geeignete Vorrichtung zur allpoligen Trennung vom Netz vorhanden sein!
- Es muss sichergestellt sein, dass die Anschlussleitungen das Heizelementrohr nicht berühren und nicht dem Heissluftstrahl ausgesetzt sind.
- Das Gerät muss gemäss Anschlusschema und Klemmanordnung auf Seiten 4, 5, 6 (Wiring Diagram) der Bedienungsanleitung angeschlossen werden:
 - Verdrahtung im **Anschlussgehäuse (9)** vornehmen.
- **ACHTUNG:** Beim MISTRAL PREMIUM die Einstellungen des Kodierschalters prüfen (siehe Wiring Diagram auf Seite 4 oder 5).
- **Kabelverschraubung für Netzanschluss (5)** und **Kabelverschraubung für Schnittstelle (6)** anziehen.
- **Abdeckung Anschlussgehäuse (2)** mit den **Schrauben (3)** montieren.
- MISTRAL an das elektrische Netz anschliessen.
- Nach Bedarf entsprechende Düse oder Reflektor auf **Heizelementrohr (4)** schieben.
- Es muss darauf geachtet werden, dass die Heissluft frei ausströmen kann, da das Gerät ansonsten durch Wärmerückstau Schaden erleiden kann (Brandgefahr!).
- Netz einschalten.
- MISTRAL PREMIUM mit **Potentiometer (10)** die gewünschte Heizleistung einstellen.
- MISTRAL PREMIUM mit **Potentiometer (10)** auf Stufe 0 stellen und somit abkühlen lassen.
- MISTRAL SYSTEM nach dem Heizbetrieb abkühlen lassen.
- Die Angaben in der folgenden Tabelle sind ausschliesslich für Nordamerika relevant. Durch Verwendung eines falschen Anschlusskabels erlischt die UL-Zertifizierung:

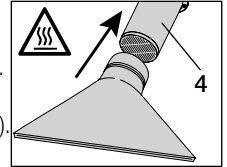

Nennstrom	≤ 10A	≤ 12A	≤ 13A	≤ 16A	≤ 18A	≤ 21A	≤ 25A
Mindest-Querschnitt	18AWG	17AWG	16AWG	15AWG	14AWG	13AWG	12AWG

Düsen- / Reflektor-Wechsel













Verbrennungsgefahr! Heizelementrohr und Düse nicht in heissem Zustand berühren.
Beim Wechseln der Düse oder des Reflektors zuvor Gerät abkühlen lassen.



Vor dem Öffnen des externen Potentiometer-Gehäuses, muss das Gerät allpolig vom Versorgungsnetz getrennt werden.

Displaybeschreibung MISTRAL SYSTEM

Symbole	Symbole
 Heizelement defekt	 Leister Service-Stelle kontaktieren
 Geräteschutz aktiviert (Überhitzung Heizelement/Geräteschutz)	 Abkühlvorgang
 Unterspannung	 Standby
 Temperatur erhöhen	 Temperatur reduzieren
 Gebläse aktiv	 Indikatorfeld zur Darstellung von Einheiten oder Informationen für das Servicemenü
 Wertefeld zur Darstellung der Soll- und Istwerte. Dabei handelt es sich um eine vierstellige Segmentanzeige ohne Dezimalpunkt	

Die Balkenanzeige symbolisiert in 5 Stufen die Gebläsedrehzahl. Gleichzeitig erscheint die Anzeige in % (1P–100P)



Gebläsedrehzahl 100 % max.



Gebläsedrehzahl 1 % min.

Heizelement-Wechsel



Der Heizelement-Wechsel darf nur von **ausgebildeten Fachleuten** oder unter deren Aufsicht vorgenommen werden.

- ❶ Gerät abkühlen lassen. MISTRAL System schaltet automatisch ab.
- ❷ Gerät vom elektrischen Netz trennen.
- ❸ Die vier **Befestigungsschrauben (13)** entfernen.
- ❹ **Heizelementrohr (4)**, Mica Tube, Dichtung und Heizelement entfernen.
- ❺ Heizelement aus der Verpackung nehmen.
- ❻ Heizelement, Dichtung, Mica Tube und **Heizelementrohr (4)** aufschieben.
- ❼ **Heizelementrohr (4)** mit vier **Befestigungsschrauben (13)** montieren.
- ❽ Gerät am elektrischen Netz anschliessen. Nennspannung, die auf dem Gerät angegeben ist, muss mit der Netzspannung übereinstimmen.

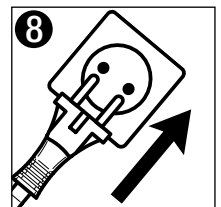
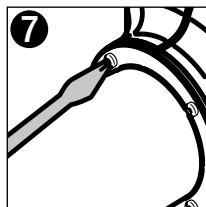
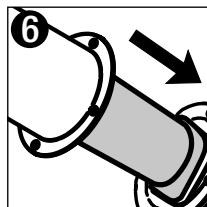
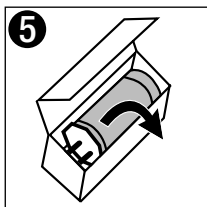
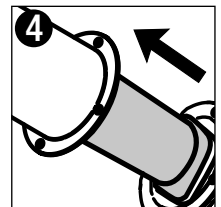
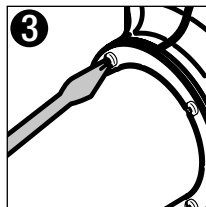
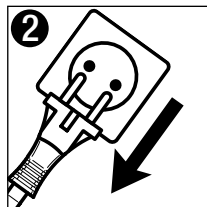
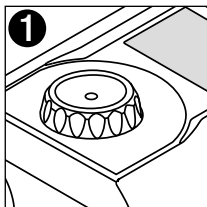

Funktion Heizelement- und Geräteschutz

Überhitzt das Heizelement oder Gerät (zu warme Lufteintrittstemperatur oder Wärmerückstau), wird die Leistungszufuhr zum Heizelement unterbrochen. Beim MISTRAL SYSTEM wird gleichzeitig der Arbeitskontakt des Alarmrelais geöffnet. Sprechen Heizelementenschutz oder Geräteschutz an, sind aus Sicherheitsgründen für die Rückstellung des Gerätes folgende Schritte zu beachten.

PREMIUM	SYSTEM
A Heizleistung ausschalten (Potentiometer (10) auf 0 stellen)	A Gerät abkühlen lassen
B Gerät abkühlen lassen	B Gerät vom elektrischen Netz trennen
	C Gerät nach 10 Sek. wieder am elektrischen Netz anschliessen.
D Lufteintritts-/ und austrittsöffnung überprüfen und gegebenenfalls reinigen.	

Düsendefinition Luftaustrittsöffnung

MISTRAL SYSTEM (Heizelementrohr \varnothing 36.5 mm)

Düseneinstellung	Düsentyp	Art-Nr.	Luftaustrittsöffnung (mm ²)
Load 0	-	-	380
Load 1	Breitschlitzdüse	108.078	400
Load 2	Breitschlitzdüse	107.261	280

Düsendefinition Luftaustrittsöffnung



MISTRAL SYSTEM (Heizelementrohr \varnothing 50 mm)

Düseneinstellung	Düsentyp	Art-Nr.	Luftaustrittsöffnung (mm ²)
Load 0	-	-	706
Load 1	Breitschlitzdüse	105.961	540
Load 2	Breitschlitzdüse	106.057	400

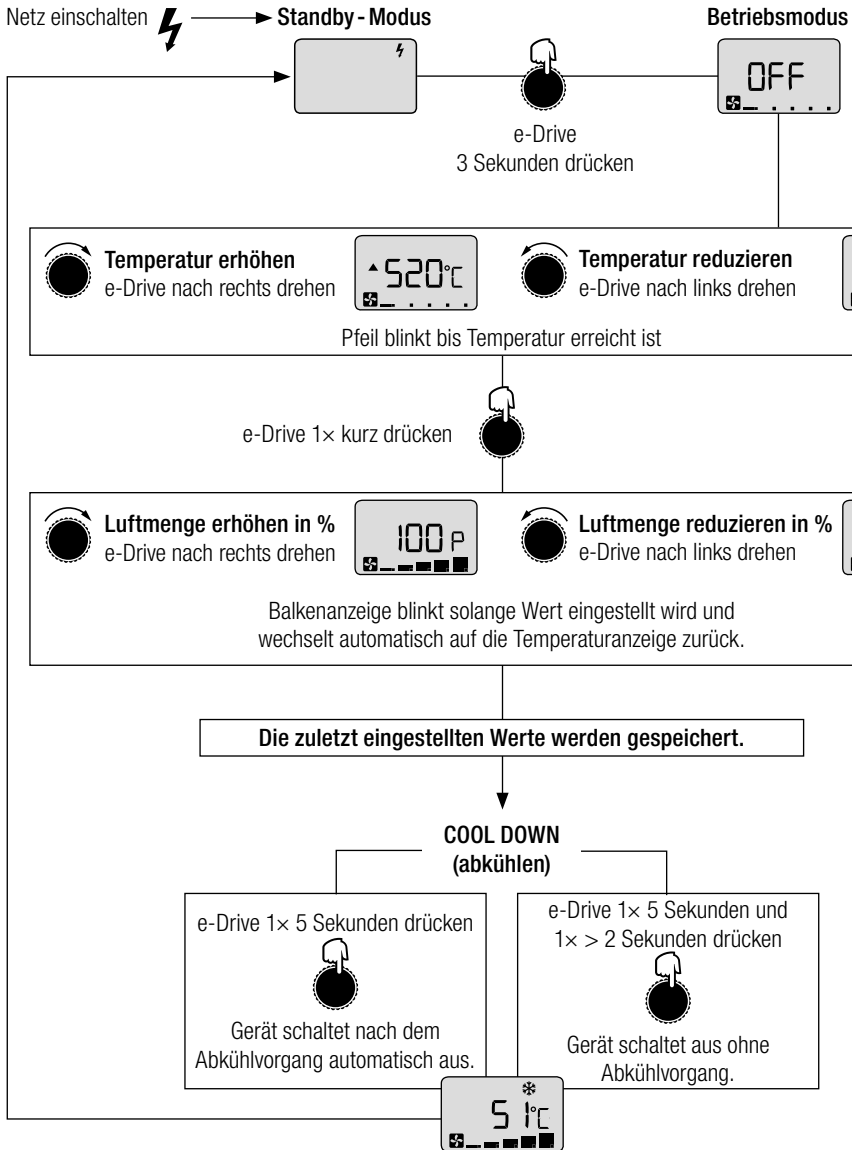
Bedienung MISTRAL SYSTEM



Konfiguration Setup-Menü MISTRAL SYSTEM

e-Drive	Funktion	e-Drive	Funktion
	1× kurz drücken = aktivieren		nach rechts drehen
	3 Sekunden drücken = bestätigen		nach links drehen



Hinweis:

Wird e-Drive 1× kurz gedrückt ohne zu bestätigen, werden die Werte nicht gespeichert.

Netz einschalten 

Standby - Modus



 3 Sekunden

Betriebsmodus



Setup-Menü



2 Sekunden drücken und gleichzeitig langsam 1/4 Umdrehung nach rechts drehen

Temperatureinheit

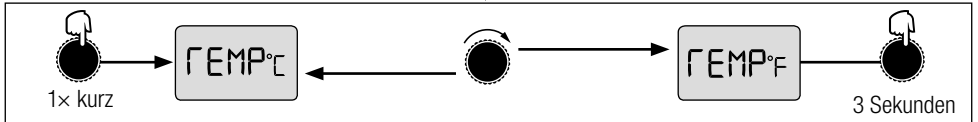

Temperaturbegrenzung 45 °C – 650 °C

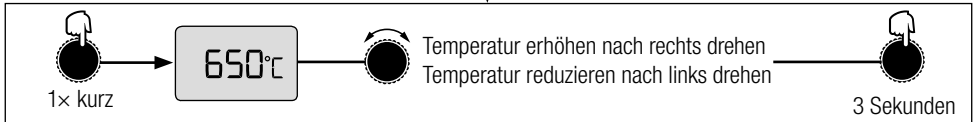

Heizung Schnittstellenvorgabe

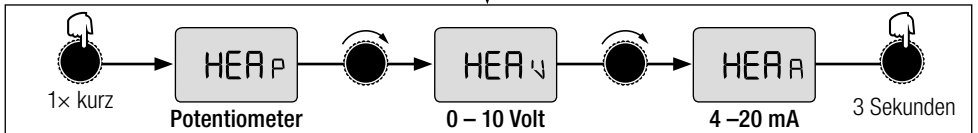

 Nächste Seite

Konfiguration Setup-Menü MISTRAL SYSTEM

Gebläse Schnittstellenvorgabe

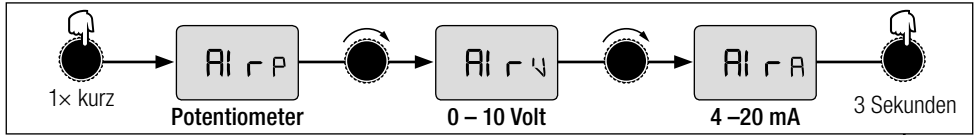

Gesteuert oder geregelt

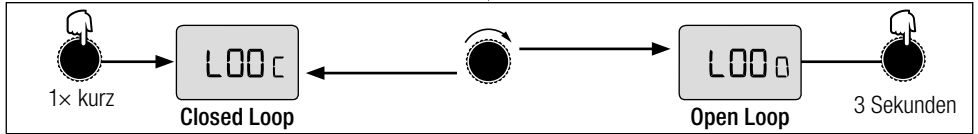

DüsenEinstellung (siehe Tabelle)

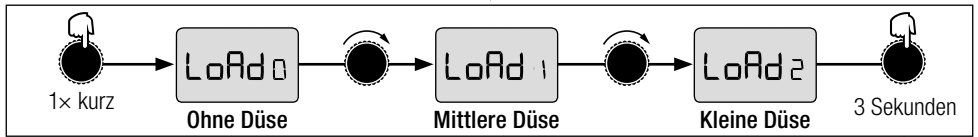

Temperatur-Offset +40°C / -40°C einstellbar

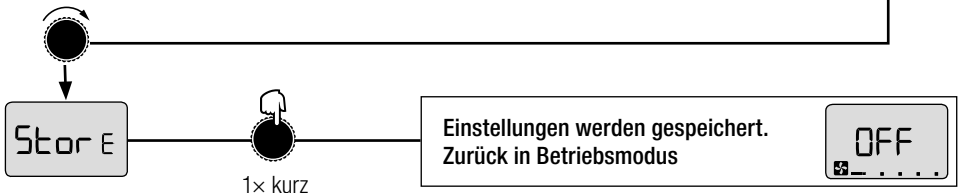
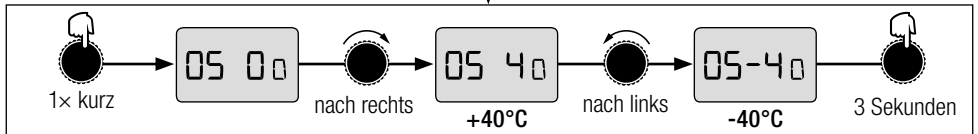

Anzeige Beschreibung

TEMP°C	Temperatur Grad Celsius
TEMP°F	Temperatur Grad Fahrenheit
HEAP	Heizung e-Drive (Potentiometer)
HEAV	Heizung Schnittstellenvorgabe 0 – 10 V
HEAA	Heizung Schnittstellenvorgabe 4 – 20 mA
Al r P	Gebläse e-Drive (Potentiometer)
Al r V	Gebläse Schnittstellenvorgabe 0 – 10 V

Anzeige Beschreibung

Al r A	Gebläse Schnittstellenvorgabe 4 – 20 mA
L00 C	Closed Loop geregelt
L00 O	Open Loop gesteuert
LoAd O	Regelparameter ohne Düse
LoAd 1	Regelparameter mittlere Düse
LoAd 2	Regelparameter kleine Düse
05-4 O	Temperatur-Offset-Einstellung +/- 40 °C
Stor E	Speichern

Fehlermeldungen

Anzeige	Bezeichnung	Fehlerursache	Fehlerbehebung
E001 C	Thermoelement	Anschluss Thermoelement	Anschluss Thermoelement kontrollieren
		Thermoelement defekt	Leister Service-Stelle kontaktieren
✖ E002 C	Temperatur Heizelement zu hoch	Heizelement defekt	Heizelement ersetzen (S. 14)
		Lufteintritt blockiert	Lufteintritt überprüfen
		Edelstahlfilter blockiert	Edelstahlfilter reinigen
		Luftaustritt blockiert	Luftaustritt überprüfen
		Falsche Düse montiert	Düse wechseln
		Falsche Düsendefinition	Düsendefinition überprüfen (S. 15)
⚡ E005 C	Unterspannung	Netzspannung < 20 % der Nennspannung	Netzspannung überprüfen
		Gerät defekt	Leister Service-Stelle kontaktieren
⚡ E008 C	Gerätetemperatur zu hoch	Umgebungstemperatur grösser als spezifiziert	Umgebungstemperatur reduzieren
		Lufteintrittstemperatur grösser als spezifiziert	Lufteintrittstemperatur reduzieren
		Lufteintritt blockiert	Lufteintritt überprüfen
		Edelstahlfilter blockiert	Edelstahlfilter reinigen
		Luftaustritt blockiert	Luftaustritt überprüfen
		Falsche Düse montiert	Düse wechseln
		Falsche Düsendefinition	Düsendefinition überprüfen (S. 15)
E003 C	Leister Service-Stelle kontaktieren		
E004 C			
E006 C			
E007 C			
E009 C			

Schulung

Leister Technologies AG sowie deren autorisierte Service-Stellen bieten kostenlose Kurse im Bereich der Anwendungen an. Informationen unter www.leister.com

3D Zeichnungen

3D-Zeichnungen sind bei ihrer Service-Stelle oder auf www.leister.com erhältlich.

Zubehör

- Es darf nur Leister-Zubehör verwendet werden.
- Leister bietet ein grosses Sortiment an Zubehör, z.B.
 - Temperaturregler
 - Düsen
 - Reflektoren
 - Externes Potentiometer
 - Filter
- Zubehör unter www.leister.com

Service und Reparatur

- Reparaturen sind ausschliesslich von autorisierten Leister Service-Stellen ausführen zu lassen. Diese gewährleisten innert nützlicher Frist einen fachgerechten und zuverlässigen Reparatur-Service mit Original-Ersatzteilen gemäss Schaltplänen und Ersatzteillisten.

Gewährleistung

- Für dieses Gerät besteht grundsätzlich Gewährleistung gemäss den gesetzlichen / länderspezifischen Bestimmungen ab Kaufdatum (Nachweis durch Rechnung oder Lieferschein). Entstandene Schäden werden durch Ersatzlieferung oder Reparatur beseitigt. Heizelemente sind von dieser Gewährleistung ausgeschlossen.
- Weitere Ansprüche sind, vorbehältlich gesetzlicher Bestimmungen, ausgeschlossen.
- Schäden, die auf natürliche Abnutzung, Überlastung oder unsachgemässe Behandlung zurückzuführen sind, werden von der Gewährleistung ausgeschlossen.
- Keine Ansprüche bestehen bei Geräten, die vom Käufer umgebaut oder verändert worden sind.

Sicherheitshinweise UL



Doppelt isoliert – bei Wartungsarbeiten ausschliesslich identische Ersatzteile verwenden.
ACHTUNG: Vor dem Öffnen der Abdeckung von der Stromversorgung trennen.



Read the Operating Instructions carefully before commissioning and store them for later availability.

Hot-air blowers

MISTRAL

PREMIUM; SYSTEM

Application

The MISTRAL hot-air blower is suitable for incorporating in machinery, plants or equipment.

Its most important applications include for example drying and heating, defrosting, accelerating and dissolving, sterilizing, smoothing, shining, activating and detaching, separating and melting, shrinking, removing.



Warning



Danger to life when opening the device as live components and connections are then exposed. The device must be disconnected from the mains for all poles before the it is opened.



Danger of fire and explosion with improper use of hot-air blowers, particularly in the vicinity of flammable materials and explosive gases.

Hidden areas such as ceilings, floors, soffit boards, walls and other panels may contain flammable materials that could be ignited by the heat gun when working in these locations. The ignition of these materials may not be apparent and could result in property damage and injury to persons



Risk of burning! Do not touch heating element tube and nozzle when they are hot. Allow the device to cool down. Do not point the hot air flow at people or animals.



Caution



The nominal voltage, specified on the device must match the mains voltage. EN 61000-3-11/UL 499/CSA C22.2 No 88; $Z_{max} = 0.180 \Omega + j 0.113 \Omega$. Consult electricity supply company if necessary.



Device **is not permitted to be operated** unsupervised. Heat can reach flammable materials that are not in view. Device may be used only by **trained specialists** or under their supervision. Children are not permitted to operate the equipment under any circumstances.







For indoor use only.





Disposal



Electrical equipment, accessories and packaging should be recycled in an environmentally friendly way. Please observe national and local regulations when disposing of our products. **For EU countries:** Do not dispose of electrical equipment with household refuse.

Technical data MISTRAL

MISTRAL 2, 4, 6 PREMIUM		2	4	6	6	6	6	6
Voltage	V~	230	120	120	230	230	230	220
Power	W	3400	2400	2400	2300	3400	4500	3100
Current A		15	20	20	10	15	20	14
Frequency	Hz	50 / 60						60
Max. air outlet temperature, open	°C	520	490	430	500	510	650	510
Max. air inlet temperature	°C	60						
Max. surrounding temperature	°C	65						
Max. air volume (20 °C surroundings)	l/min.	350	300	350	300	350	400	350
Max. static pressure	kPa	3.5	3.5	2.5	2.5	2.5	3.0	2.5
Emission level	L _{pA} (dB)	65						
Weight	kg	1.4	1.4	1.4	1.2	1.4	1.5	1.4
Interface (not potential free)		External potentiometer for heat capacity						
Dimensions (size)		Page 3						
Mark of conformity								
Safety mark								
Protection class II								

MISTRAL 6 SYSTEM		6						
Voltage	V~	100	120	200	230	230	230	220
Power	W	1500	2400	3000	2300	3400	4500	3100
Current	A	15	20	15	10	15	20	14
Frequency	Hz	50 / 60						60
Max. air outlet temperature, open	°C	650						
Max. air inlet temperature	°C	60						
Max. surrounding temperature	°C	65						
Min. air volume (air target value 1%)	l/min.	100	100	100	100	100	100	100
Max. air volume (air target value 100 %)	l/min.	300	350	350	300	350	400	350
Max. static pressure	kPa	3.5	3.5	3.5	3.5	3.5	3.5	3.5
Emission level	L _{pA} (dB)	65						
Weight	kg	1.2	1.4	1.4	1.2	1.4	1.5	1.4
Interface (potential free)		4-20mA and 0-10V for heating capacity & air volume alarm output						
Dimensions (size)		Page 3						
Mark of conformity								
Safety mark								
Protection class II								

We reserve the right to make technical changes

Technical data device function

MISTRAL	PREMIUM	SYSTEM
Integrated power electronics	•	•
Protection from overheating heating element and device	•	•
Integrated code switch for potentiometer (internal/external)	•	
Infinitely adjustable heating capacity with potentiometer	•	
Heating capacity separately switchable for cool down function	•	
Display for showing target/actual values (°C oder °F)		•
Progressively adjustable temperature and air volume with "e-drive"		•
Integrated temperature probe		•
Alarm output (relay contact)		•
Automatic cool-down function		•
Adjustable temperature limiter		•
Adjustable temperature offset		•
Remote control interface for temperature or capacity target		•
Remote control interface for air volume target		•
3-level regulation parameter adjustment (open, medium and small nozzle)		•

Technical data interfaces

PREMIUM	External Potentiometer	Insulation	Not potential-free
		Resistance	10 – 100 kOhm
SYSTEM	General	Insulation IEC/EN 60747-5-2	AC 1414 Vpeak
		Polarity protection	
		Zero point correction	
	Voltage entry	Voltage 0 – 10V	DC 0... 10V (Ripple < 0.07 V at 5 °C resolution) (Ripple < 0.4 V at 5 °C resolution)
		Max. input voltage	DC 12 V
		Index input impedance	33.7 kOhm
	Current input	Current 4 - 20 mA (2-wire technology)	DC 4... 20 mA (Ripple < 0.1 mA at 5 °C resolution) (Ripple < 0.7 mA at 5 °C resolution)
		Max. input current	DC 22 mA
		Index input impedance	159 Ohm
	Alarm output (relay contact)	Max. live voltage	AC 250 V, DC 30 V
		Max. currents	AC 3 A, DC 3 A
		Max. contact impedance	100 mOhm at DC 24 V / 1 A
		Contact type	SPST-NO
		Insulation contact to spool	AC 4000 V 1 min.
Insulation contact to contact		AC 1000 V 1 min.	

Versions

MISTRAL	2 PREMIUM	4 PREMIUM	6 PREMIUM	6 SYSTEM
Brushless motor			•	•
Brush motor with replacement carbon brushes		•		
Brush motor	•			

Technical data Functions

PREMIUM	Int. or ext. Potentiometer	Heating capacity	Capacity target 0...100 % / OFF
SYSTEM	e-drive or interface	Temperature (closed Loop)	Temperature target OFF, 50...650 °C; 5 °C resolution
		Temperature (open Loop)	Capacity target OFF, 5...100%; 5 % resolution
		Air volume	Air volume target 1, 5...100%; 5 % resolution

MISTRAL SYSTEM Temperature / air volume diagram

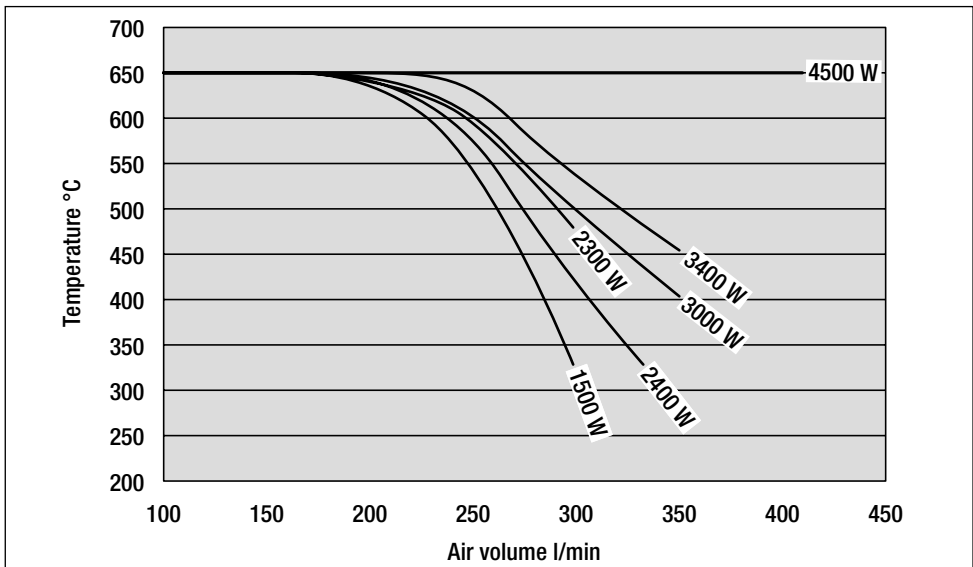

MISTRAL SYSTEM interface / activation

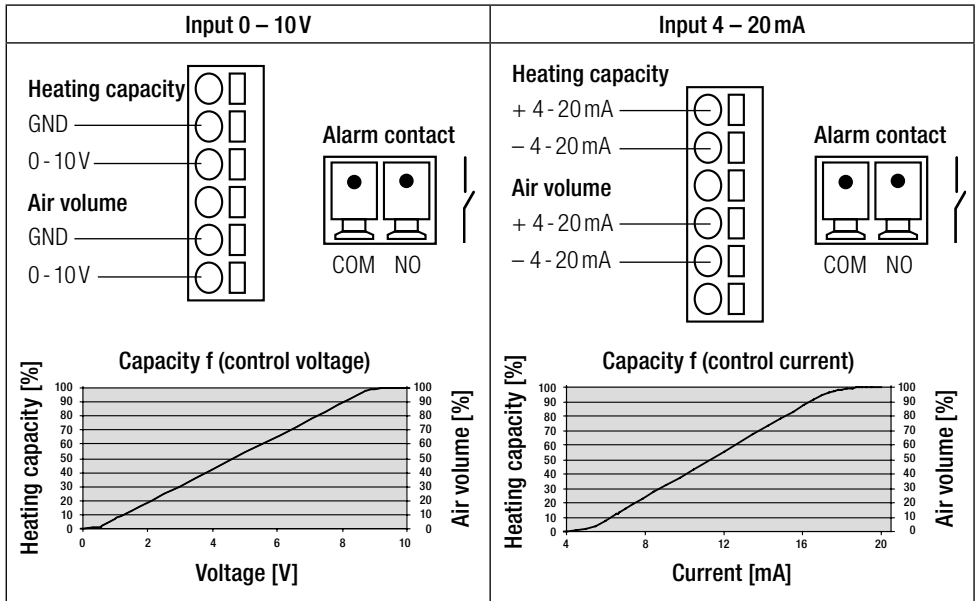

CAUTION:

When using the device as a built-in unit, a suitable mechanism **for disconnecting all poles** from the mains with a **contact space of at least 3 mm** must be present in the power supply cord.

Description of MISTRAL PREMIUM; SYSTEM

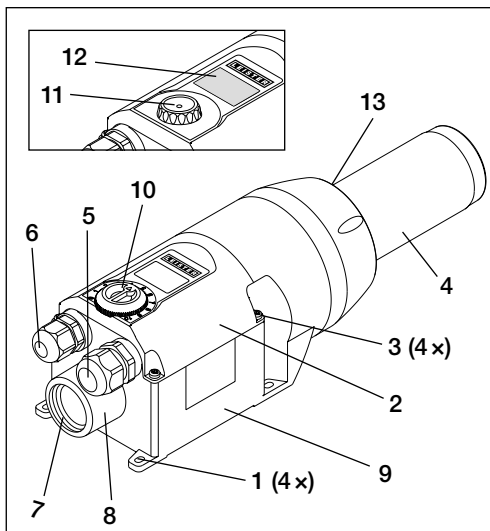

MISTRAL PREMIUM/SYSTEM

- 1 Mounting tabs
- 2 Connection housing cover
- 3 Screws for connection housing
- 4 Heating element pipe
- 5 Cable gland for power supply cord
- 6 Cable gland for interface
- 7 Air inlet valve with internal thread G 1"
- 8 Connection \varnothing 38 for air hose or stainless steel filter
- 9 Connection housing
- 13 Attachment screws

MISTRAL PREMIUM

- 10 Potentiometer for adjusting the heat capacity

MISTRAL SYSTEM

- 11 e-drive for temperature/ air settings
- 12 Display

Preparation of MISTRAL PREMIUM; SYSTEM

- Remove MISTRAL from the packaging.
- Loosen the **screws (3)** and **open the cover of the connection housing (2)** .
- **Loosen the cable gland for the power supply (5)** .
- If needed, loosen the **cable gland for interface (6)** .

Installation

- The device may only be installed by a trained technician.
- The surrounding temperature may not be higher than 65 °C
- The installation must ensure that
 - only cold air is taken in.
 - no (warm air) back pressure arises.
 - the device is not exposed to the flow of hot air from another device.
- Protect MISTRAL against mechanical vibrations and shocks.
- Attach MISTRAL with four screws Ø M4 to the **mounting tabs (1)** .
- Avoid positioning the device perpendicularly. If a perpendicular position is absolutely necessary, make sure device can cool off – **Overheating risk**.
- For installation dimensions, see page 3 (Size)
- If the air contains dust use a Leister stainless steel filter (see accessories) and push it on the **Connection ø 38 for air hose or stainless steel filter (8)**.
- In the case of particularly critical dusts (e.g. metal, electrically conductive or damp dusts), special filters must be used to avoid short-circuits in the device.



The local standards and guidelines that apply must always be observed during installation (e.g. special fire protection guidelines, etc.).



Caution: Always operate the device with air supply!

Connection

- The MISTRAL must be connected by a trained technician.
- A suitable apparatus for disconnecting the device from the mains for all poles must be present in the power supply cord!
- It must be ensured that the connection cords have no contact with the heating element pipe and that they are not exposed to the jet of hot air.
- The device must be connected in accordance with the Wiring Diagram on pages 4, 5, 6 of the Operating Manual:
 - Carry out the wiring in the **connection housing (9)** .
- **CAUTION:** Check the settings for the code switch for the MISTRAL PREMIUM (see Wiring Diagram on page 4 or 5).
- **Tighten the cable gland for the power supply cord (5) and the cable gland for the interface (6)** .
- **Attach the cover for the connection housing (2) using the screws (3)** .
- Connect MISTRAL to the mains.
- If needed, slide the matching nozzle or reflector onto the **heating element pipe (4)** .
- Care must be taken to ensure that the hot air can flow out freely, as otherwise the device could suffer damage from warm air back pressure (danger of fire!).
- Switch on the mains.
- Set the desired heat capacity using the MISTRAL PREMIUM **potentiometer (10)** .
- Set MISTRAL PREMIUM **potentiometer (10)** to level 0 and allow it to cool off.
- Allow MISTRAL SYSTEM to cool down after heating operation.
- The information in the following table is solely relevant for North America. The UL certification becomes void if an incorrect connection cable is used:

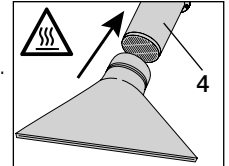

Nominal current	≤ 10A	≤ 12A	≤ 13A	≤ 16A	≤ 18A	≤ 21A	≤ 25A
Minimum cross-section	18AWG	17AWG	16AWG	15AWG	14AWG	13AWG	12AWG

Changing nozzle / reflector













Risk of burning! Do not touch heating element tube and nozzle when they are hot.
Before changing the nozzle or the reflector allow the device to cool off.



Before opening the external potentiometer housing, the device must be disconnected at all poles from the power supply line.

Description of MISTRAL SYSTEM display

Symbol		Symbol	
	Heating element is faulty		Contact a Leister service center.
	Activate device protection (Overheating heating element/device protection)		Cooling process
	Undervoltage		Standby
	Increase temperature		Reduce temperature
	Active blower		Indicator field for displaying units or information for the service menu
	Field for displaying the target and actual values. This is a four-digit segment display without decimal points.		

The bar display symbolizes the blower speed at 5 levels. At the same time, it appears in % (1 P–100 P)



Blower speed 100% max.



Blower speed 1 % min.

Change heating element



Changing the heating element may be done only by a **trained technician** or under supervision by such.

- ❶ Allow the device to cool down. MISTRAL System automatically shuts down.
- ❷ Disconnect the power cord from the mains.
- ❸ Remove the **four attachment screws (13)**.
- ❹ **Remove the heating element pipe (4)**, Mica Tube, seal and heating element.
- ❺ Remove the heating element from the packaging.
- ❻ Slide the heating element, Mica Tube and **heating element pipe (4)** on.
- ❼ **Install the heating element pipe (4)** with four **attachment screws (13)**.
- ❽ Connect the power cord to the mains. The nominal voltage, specified on the device must match the mains voltage.

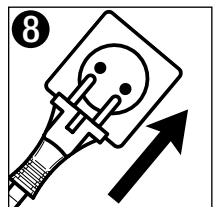
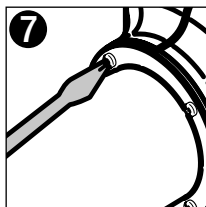
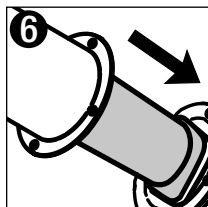
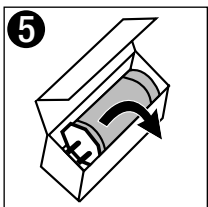
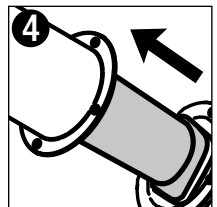
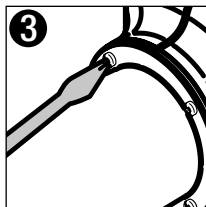
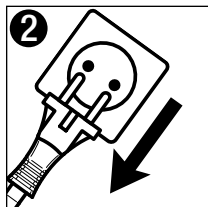
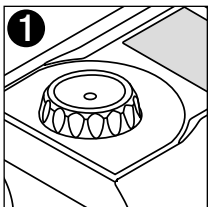

Function heating element and tool protection

If the heating element or device overheats (air intake temperature is too warm or warm air back pressure), the power to the heating element is interrupted. For the MISTRAL SYSTEM, the work contact of the alarm relay opens simultaneously. If the heating element protection or device protection signals, the following steps should be followed to reset the device for safety reasons.

PREMIUM	SYSTEM
A Switch off heating capacity (set potentiometer (10) to 0)	A Let the device cool
B Let the device cool	B Disconnect the power cord from the mains
	C After 10 seconds, plug the device into the mains again.
D Check air intake / and output opening and clean if necessary.	

Nozzle definition air output opening

MISTRAL SYSTEM (heating element pipe \varnothing 36.5 mm)

Nozzle setting	Nozzle type	Item no.	Air output opening (mm ²)
Load 0	-	-	380
Load 1	Wide slot nozzle	108.078	400
Load 2	Wide slot nozzle	107.261	280

Nozzle definition air output opening



MISTRAL SYSTEM (heating element pipe \varnothing 50 mm)

Nozzle setting	Nozzle type	Item no.	Air output opening (mm ²)
Load 0	-	-	706
Load 1	Wide slot nozzle	105.961	540
Load 2	Wide slot nozzle	106.057	400

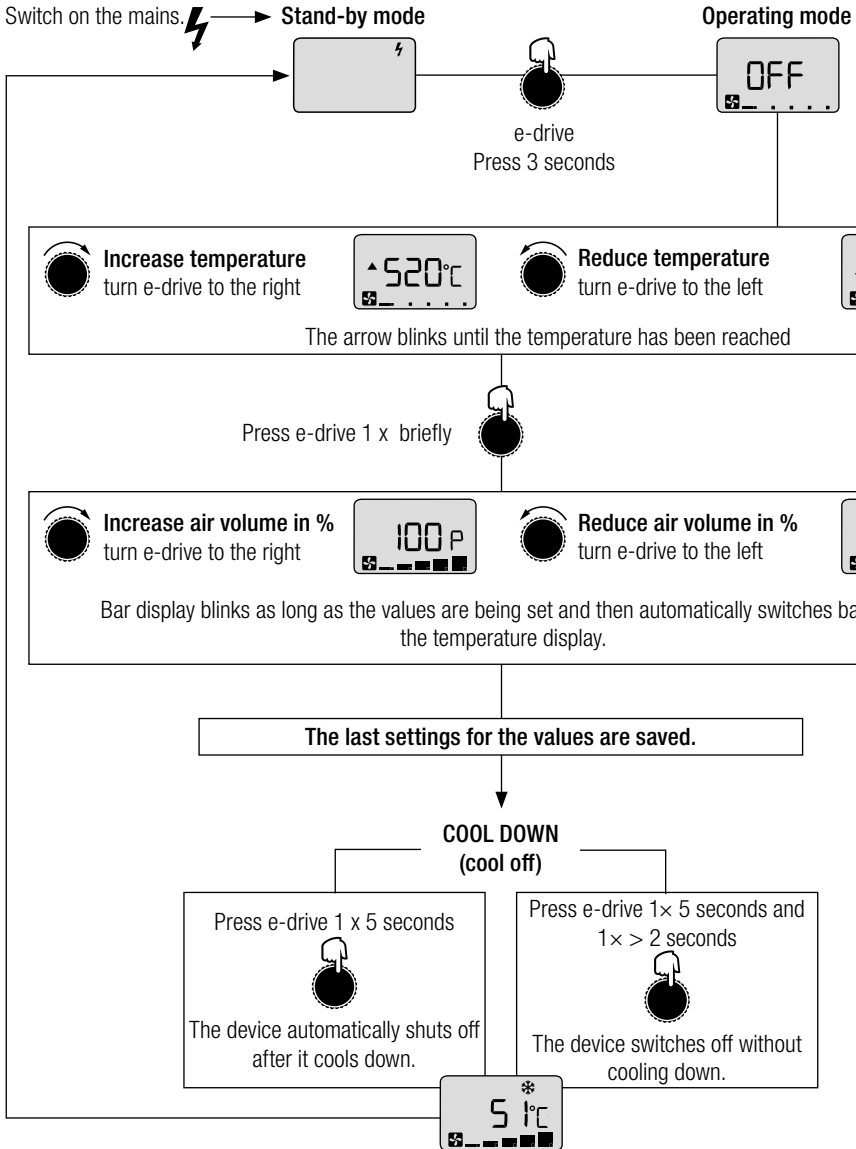
Operation MISTRAL SYSTEM



Configuration set-up menu MISTRAL SYSTEM

e-drive	Function	e-drive	Function
	Press briefly 1 x = activate		turn to the right
	Press 3 seconds = confirm		turn to the left



Note:

If the e-drive is pressed briefly 1x without confirming it, the values will not be saved.

Switch on the mains. ⚡

Stand-by mode



Operating mode



Set-up menu

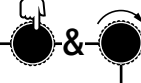

Press 2 seconds and at the same time slowly give it a 1/4 -turn to the right.

Temperature unit

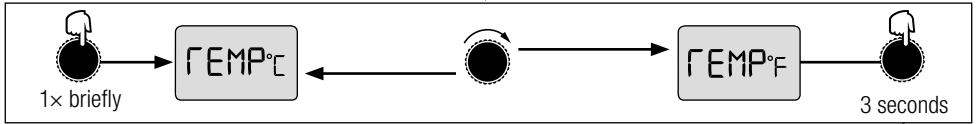

Temperature limit 45 °C – 650 °C

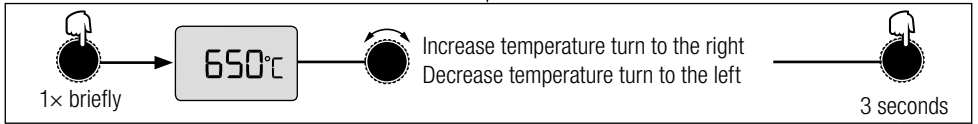

Heating interface target

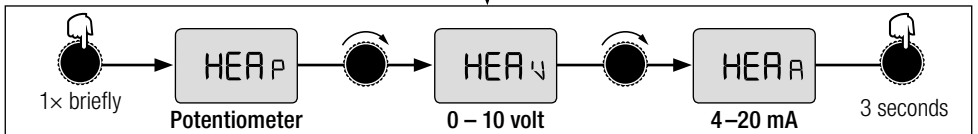

Next page

Configuration set-up menu MISTRAL SYSTEM

Blower interface target

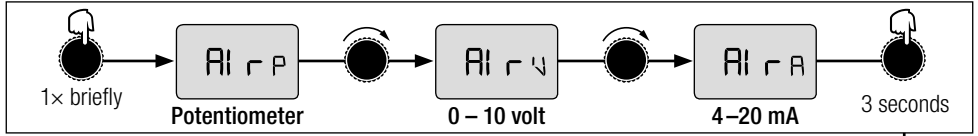

Controlled or regulated

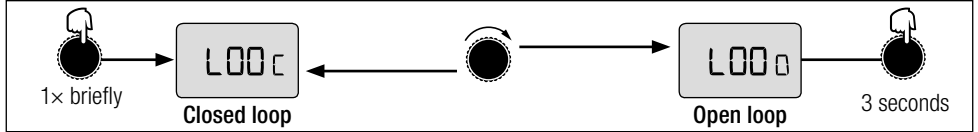

Nozzle setting (see table)

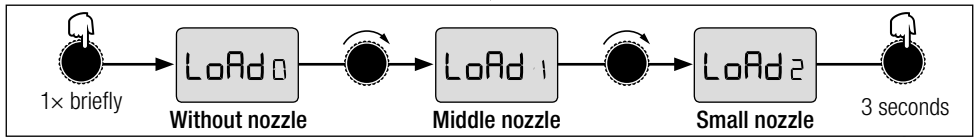



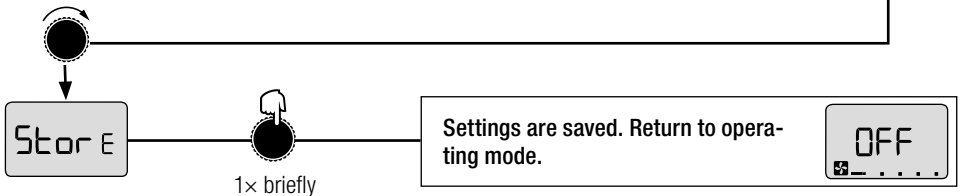
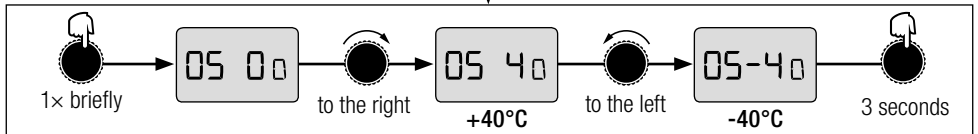





Temperature offset +40°C / -40°C adjustable



Display	Description
TEMP°C	Temperature degrees Celsius
TEMP°F	Temperature degrees Fahrenheit
HEA P	Heating e-drive (potentiometer)
HEA V	Heating interface target 0 – 10 V
HEA A	Heating interface target 4 – 20 mA
Al r P	Blower e-drive (potentiometer)
Al r V	Blower interface target 0 – 10 V

Display	Description
Al r A	Blower interface target 4 – 20 mA
L00 C	Closed loop regulated
L00 □	Open loop controlled
LoAd □	Regulation parameter without nozzle
LoAd 1	Regulation parameter middle nozzle
LoAd 2	Regulation parameter small nozzle
05-4 □	Temperature offset settings +/- 40 °C
Stor E	Save

Error messages

Display	Designation	Cause of error	Elimination of error
E001 	Thermocouple	Thermocouple connection	Check thermocouple connection
		Thermocouple is defective	Contact a Leister Service Center
* E002 	Heating element temperature too high	Heating element is faulty	Replace heating element (p. 14)
		Air intake blocked	Check air intake
		Stainless steel filter blocked	Clean stainless steel filter
		Air outlet blocked	Check air outlet
		Wrong nozzle mounted	Replace nozzle
		Wrong nozzle definition	Check nozzle definition (p. 15)
E005 	Undervoltage	Mains voltage < 20% of the nominal voltage	Check nominal voltage
		Device defective	Contact a Leister Service Center
E008 	Device temperature too high	Ambient temperature higher than specified	Reduce ambient temperature
		Air intake temperature higher than specified	Reduce air intake temperature
		Air intake blocked	Check air intake
		Stainless steel filter blocked	Clean stainless steel filter
		Air outlet blocked	Check air outlet
		Wrong nozzle mounted	Replace nozzle
		Wrong nozzle definition	Check nozzle definition (p. 15)
E003 	Contact a Leister Service Center		
E004 			
E006 			
E007 			
E009 			

Training

Leister Technologies AG and its authorised service points provide free courses in the area of applications. Information at www.leister.com.

3D drawings

3D drawings are available from your Service Centres or at www.leister.com

Accessories

- Only Leister accessories may be used.
- Leister offers a wide range of accessories, e.g.
 - Temperature controls
 - Nozzles
 - Reflectors
 - External potentiometer
 - Filter
- Accessories at www.leister.com

Service and Repairs

- Repairs should only be carried out by authorised Leister Service Centres. They guarantee a correct and reliable repair service within reasonable period, using original spare parts in accordance with the circuit diagrams and spare parts lists.

Warranty

- For this tool, we generally provide a warranty in accordance with the statutory/country-specific regulations from the date of purchase (verified by invoice or delivery document). Damage that has occurred will be corrected by replacement or repair. Heating elements are excluded from this warranty.
- Additional claims shall be excluded, subject to statutory regulations.
- Damage caused by normal wear, overloading or improper handling is excluded from the guarantee.
- Warranty claims will be rejected for tools that have been altered or changed by the purchaser.

UL safety instructions



DOUBLE INSULATED – WHEN SERVICING USE ONLY IDENTICAL REPLACEMENT PARTS.
CAUTION: DISCONNECT FROM THE SUPPLY BEFORE OPENING THIS COVER



Prima della messa in servizio leggere attentamente le presenti istruzioni per l'uso e conservarle per una futura consultazione.

Soffiante ad aria calda MISTRAL PREMIUM; SYSTEM

Applicazione

Il soffiante ad aria calda MISTRAL è adatto all'integrazione in macchine, impianti o apparecchi.

Tra le applicazioni più importanti sono altresì presenti: **essiccazione e riscaldamento, sbrinamento, accelerazione e scioglimento, sterilizzazione, levigatura, lucidatura, attivazione e rimozione, separazione e fusione, termoretrazione ed eliminazione.**



Avvertenza



Pericolo di morte in caso di apertura dell'apparecchio: contiene componenti e contatti sotto tensione non protetti. Prima di aprire l'apparecchio, accertarsi della sua disinserzione onnipolare.



Pericolo di incendio ed esplosione in caso di uso non conforme di apparecchi ad aria calda, specialmente nelle vicinanze di materiali infiammabili e gas esplosivi. Aree nascoste come soffitti, pavimenti, pannelli di fondo, muri e altre zone simili, possono contenere materiali infiammabili che potrebbero essere attivati dalla pistola ad aria calda quando si lavora nelle vicinanze. L'accensione di questi materiali potrebbe non essere evidente e potrebbe causare danni materiali e infortuni agli operatori.



Pericolo di scottature! Non toccare il tubo dell'elemento riscaldante e l'ugello quando sono roventi. Fare raffreddare l'apparecchio. Non dirigere il getto di aria calda verso persone o animali.



Attenzione



La tensione nominale indicata sull'apparecchio deve corrispondere alla tensione di alimentazione. Impedenza di alimentazione massima $0.180 \Omega + j 0.113 \Omega$, secondo EN 61000-3-11/UL 499/CSA C22.2 n. 88. In caso di dubbi, consultare la società elettrica responsabile.



L'apparecchio deve essere **azionato** sotto controllo visivo. Il calore può raggiungere materiali infiammabili che si trovano al di fuori del campo visivo. L'impiego dell'apparecchio è **consentito esclusivamente** a personale qualificato o sotto il monitoraggio di quest'ultimo. È tassativamente vietato l'impiego da parte dei bambini.



Solo per uso interno.

Smaltimento



Gli apparecchiature elettriche, gli accessori e gli imballaggi devono essere riciclati nel rispetto dell'ambiente. Per lo smaltimento dei nostri prodotti, osservare le norme nazionali e locali. **Per i paesi dell'UE:** Non smaltire gli apparecchiature elettriche insieme ai rifiuti domestici.

Specifiche tecniche MISTRAL

MISTRAL 2, 4, 6 PREMIUM		2	4	6	6	6	6	6
Tensione	V~	230	120	120	230	230	230	220
Potenza	W	3400	2400	2400	2300	3400	4500	3100
Corrente	A	15	20	20	10	15	20	14
Frequenza	Hz	50 / 60						60
Temperatura max. aria in uscita, impostabile	°C	520	490	430	500	510	650	510
Temperatura max. aria in entrata	°C	60						
Temperatura ambiente max.	°C	65						
Quantità aria max. (20°C temp. ambiente)	l/min.	350	300	350	300	350	400	350
Pressione statica max.	kPa	3.5	3.5	2.5	2.5	2.5	3.0	2.5
Livello di emissione	L _{pA} (dB)	65						
Peso	kg	1.4	1.4	1.4	1.2	1.4	1.5	1.4
Interfaccia (non priva di potenziale)		Potenziometro esterno per la potenza termica						
Dimensioni e ingombri		Pagina 3						
Marchio di omologazione		CE						
Marchio di sicurezza		Ⓢ			Ⓢ	UL US		Ⓢ
Classe di protezione II		□						

MISTRAL 6 SYSTEM		6						
Tensione	V~	100	120	200	230	230	230	220
Potenza	W	1500	2400	3000	2300	3400	4500	3100
Corrente	A	15	20	15	10	15	20	14
Frequenza	Hz	50 / 60						60
Temperatura max. aria in uscita, impostabile	°C	650						
Temperatura max. aria in entrata	°C	60						
Temperatura ambiente max.	°C	65						
Quantità aria min.								
(valore nominale aria 1 %)	l/min.	100	100	100	100	100	100	100
Quantità aria max.								
(valore nominale aria 100 %)	l/min.	300	350	350	300	350	400	350
Pressione statica max.	kPa	3.5	3.5	3.5	3.5	3.5	3.5	3.5
Livello di emissione	L _{pA} (dB)	65						
Peso	kg	1.2	1.4	1.4	1.2	1.4	1.5	1.4
Interfaccia (priva di potenziale)		4-20 mA e 0-10 V per la potenza termica e per la quantità d'aria Uscita allarme						
Dimensioni e ingombri		Pagina 3						
Marchio di omologazione		CE						
Marchio di sicurezza		Ⓢ			Ⓢ	UL US		Ⓢ
Classe di protezione II		□						

Modifiche tecniche riservate

Specifiche tecniche Funzionalità dell'apparecchio

MISTRAL	PREMIUM	SYSTEM
Elettronica di potenza integrata	•	•
Protezione contro surriscaldamento dell'elemento riscaldante e dell'apparecchio	•	•
Interruttore di codifica integrato per potenziometro (interno/esterno)	•	
Potenza regolabile in modo continuo con apposito potenziometro	•	
Potenza termica azionabile separatamente per la funzione Cool Down	•	
Display per la visualizzazione di valori nominali o reali (°C oppure °F)		•
Temperatura e quantità aria regolabili in modo continuo grazie all'e-drive		•
Sonda di temperatura integrata		•
Uscita allarme (contatto relè)		•
Funzione di raffreddamento automatico		•
Limitazione di temperatura regolabile		•
Scostamento termico regolabile		•
Interfaccia telecomandata per temperatura o potenza predefinita		•
Interfaccia telecomandata per quantità aria predefinita		•
Adattamento dei parametri di regolazione su 3 livelli (ugello aperto, intermedio e piccolo)		•

Specifiche tecniche interfaccia

PREMIUM	Potenziometro esterno	Isolamento	Non privo di potenziale	
		Resistenza	10-100 kOhm	
SYSTEM	Generale	Protezione IEC/EN 60747-5-2	CA 1414V di picco	
		Protezione contro inversione di polarità		
		Compensazione del punto neutro		
	Ingressi tensione	Tensione 0 – 10 V		CC 0...10V (Fattore di cresta < 0,07V con 5 °C di risoluzione) (Fattore di cresta < 0,4V con 5 % di risoluzione)
			Tensione d'ingresso max.	CC 12V
		Resistenza d'ingresso nominale		33,7 kOhm
		Ingressi corrente	Corrente 4–20 mA (tecnica a 2 conduttori)	
	Corrente d'ingresso max.			CC 22 mA
	Resistenza d'ingresso nominale			159 Ohm
	Uscita allarme (Contatto relè)		Tensioni max.	
		Correnti max.		CA 3A, CC 3A
		Massima resistenza di contatto		100 mOhm a CC 24V / 1 A
		Tipo di contatto		SPST-NO
Contatto isolamento - bobina			CA 4000V 1 min.	
Contatto isolamento - contatto			CA 1000V 1 min.	

Versioni

MISTRAL	2 PREMIUM	4 PREMIUM	6 PREMIUM	6 SYSTEM
Motore senza carboncini			•	•
Motore a carboncini con cambio dei carboni		•		
Motore a carboncini	•			

Specifiche tecniche Funzionalità

PREMIUM	Potenziometro int. o est.	Potenza termica	Indicazione potenza 0...100% / OFF
SYSTEM	e-Drive o interfaccia	Temperatura (closed loop)	Indicazione temperatura OFF, 50...650 °C; 5 °C di risoluzione
		Temperatura (open loop)	Indicazione potenza OFF, 5...100%; 5% di risoluzione
		Quantità d'aria	Indicazione quantità d'aria 1, 5...100%; 5% di risoluzione

Schema temperatura / quantità d'aria MISTRAL SYSTEM

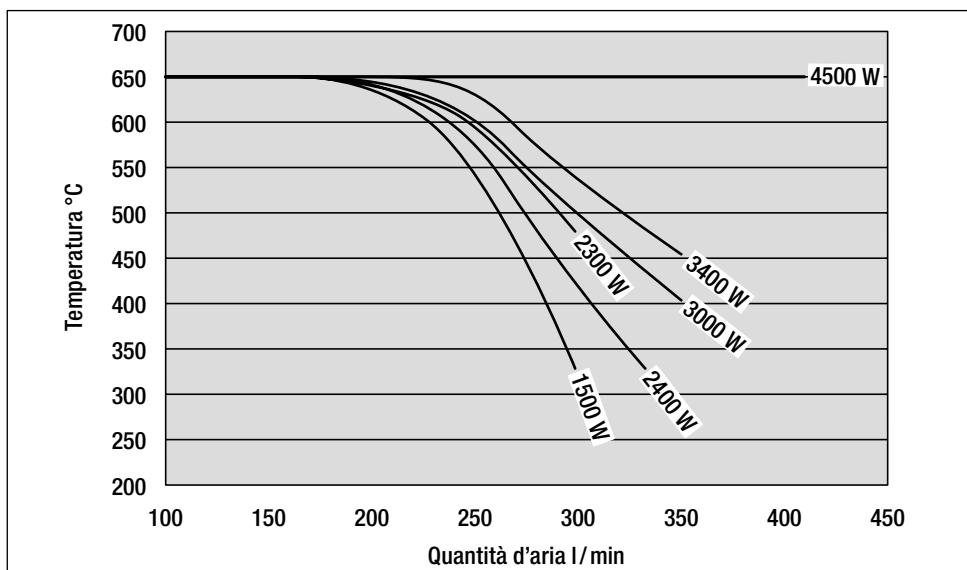

Interfaccia / Comando MISTRAL SYSTEM

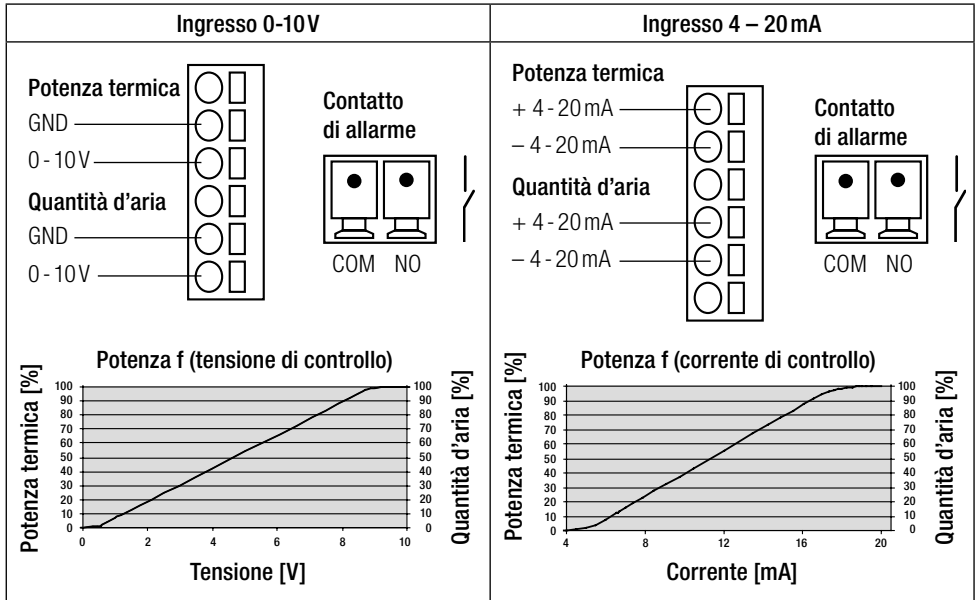

ATTENZIONE:

Se l'apparecchio viene montato in un impianto, prevedere nel collegamento alla rete un idoneo **dispositivo per la disinserzione onnipolare** della rete **almeno con 3 mm di distanza** dai contatti.

Descrizione MISTRAL PREMIUM; SYSTEM

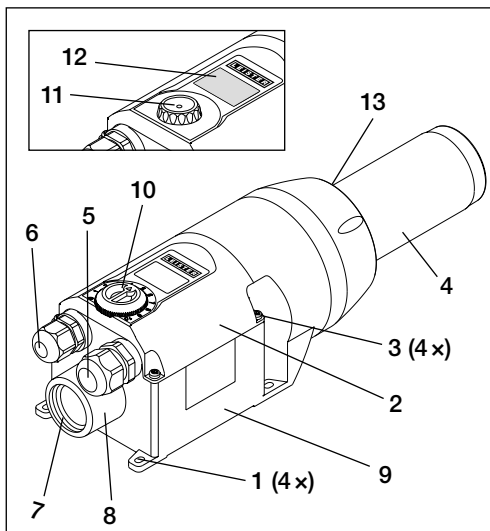

MISTRAL PREMIUM; SYSTEM

- 1 Squadrette asolate
- 2 Coperchio vano di collegamento
- 3 Viti per vano di collegamento
- 4 Tubo elemento riscaldante
- 5 Pressacavo per allacciamento elettrico
- 6 Pressacavo per interfaccia
- 7 Flangia per presa d'aria con filettatura interna G 1"
- 8 Raccordo \varnothing 38 per tubi flessibili pneumatici o filtri in acciaio inox
- 9 Vano di collegamento
- 13 Viti di fissaggio

MISTRAL PREMIUM

- 10 Potenziometro per la configurazione dell'emissione di calore

MISTRAL SYSTEM

- 11 e-Drive per le impostazioni di aria e temperatura
- 12 Display

Preparazione MISTRAL PREMIUM; SYSTEM

- Estrarre il MISTRAL dall'imballaggio.
- Aprire il coperchio **del vano di collegamento (2)** allentando **le viti(3)**.
- **Allentare il pressacavo per l'allacciamento elettrico(5)**.
- Se necessario, **allentare il pressacavo per l'interfaccia (6)**.

Montaggio

- L'apparecchio deve essere installato solo da personale qualificato.
- La temperatura non deve superare 65 °C
- L'installazione deve garantire che
 - l'apparecchio sia alimentato solo da aria fredda
 - non si formino ristagni (altresi di calore)
 - l'apparecchio non sia interessato da getti di aria calda emessi da altri dispositivi
- Proteggere il MISTRAL da vibrazioni e sollecitazioni di natura meccanica.
- Fissare il MISTRAL mediante quattro viti Ø M4 alle **squadrette asolate (1)**.
- Evitare di mettere l'apparecchio in posizione verticale. Se non è possibile evitare di mettere l'apparecchio in posizione verticale, è opportuno garantire tutti i casi il raffreddamento dell'apparecchio – **Pericolo di surriscaldamento**.
- Dimensioni di ingombro: vedere pagina 3 (Dimensioni)
- In presenza di aria che contenga polveri utilizzare il filtro in acciaio inox (vedere gli accessori) e farlo scorrere sulla **raccordo Ø 38 per tubi flessibili pneumatici o filtri in acciaio inox (8)**
- In caso di polveri critiche, come ad esempio le polveri di metalli, quelle che conducono corrente elettrica o quelle umide, è necessario utilizzare filtri speciali per evitare eventuali cortocircuiti nell'apparecchio.



Le linee guida e gli standard locali vigenti devono essere sempre osservati durante l'installazione (ad es. linee guida speciali sulla protezione antincendio e così via).



Attenzione: fare funzionare sempre l'apparecchio con alimentazione d'aria!

Collegamento

- Il MISTRAL deve essere collegato alla rete solo da personale qualificato.
- Nell'allacciamento alla rete deve essere presente un idoneo dispositivo per il distacco onnipolare dalla rete!
- Assicurarsi che i cavi di collegamento non siano a contatto con il tubo dell'elemento riscaldante e che non siano esposti al getto di aria calda.
- L'apparecchio deve essere collegato secondo lo schema di collegamento e la piedinatura indicati alle pagine 4, 5, 6 (schema elettrico) delle istruzioni per l'uso:
 - Effettuare il cablaggio **nel vano di collegamento (9)**.
- **ATTENZIONE:** Nel MISTRAL PREMIUM è necessario verificare la configurazione dell'interruttore di codifica (vedere lo schema elettrico a pagina 4 o 5).
- **Serrare il pressacavo per l'allacciamento elettrico (5) e il pressacavo per l'interfaccia (6).**
- **Applicare il coperchio del vano di collegamento (2) mediante le viti (3).**
- Collegare l'apparecchio MISTRAL alla rete elettrica.
- Applicare l'ugello appropriato o il riflettore **al tubo dell'elemento riscaldante (4)** in base alla necessità.
- Fare in modo che il flusso d'aria calda possa scorrere liberamente per evitare che il riflusso caldo possa danneggiare l'apparecchio (rischio di incendio!).
- Inserire l'alimentazione elettrica.
- Configurare il MISTRAL PREMIUM mediante **il potenziometro (10)** sul valore di emissione di calore scelto.
- Impostare il MISTRAL PREMIUM con **il potenziometro (10)** sul livello 0 e lasciare raffreddare.
- Lasciare raffreddare il MISTRAL SYSTEM al termine dell'emissione di calore.
- Le informazioni nella seguente tabella sono esclusivamente pertinenti per gli Stati Uniti. La certificazione UL viene annullata se è stato utilizzato un cavo di collegamento errato:

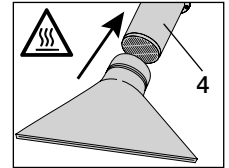

Corrente nominale	≤ 10 A	≤ 12 A	≤ 13 A	≤ 16 A	≤ 18 A	≤ 21 A	≤ 25 A
Sezione trasversale minima	18 AWG	17 AWG	16 AWG	15 AWG	14 AWG	13 AWG	12 AWG

Sostituzione degli ugelli e dei riflettori











Pericolo di scottature! Non toccare il tubo dell'elemento riscaldante e l'ugello quando sono roventi. Quando si sostituiscono l'ugello o il riflettore, fare raffreddare l'apparecchio.



Prima di aprire l'alloggiamento del potenziometro esterno, accertarsi della disinserzione onnipolare dell'apparecchio.

Descrizione dei simboli sul display MISTRAL SYSTEM

Legenda	Legenda
 Guasto dell'elemento riscaldante	 Contattare il centro di assistenza Leister
 Protezione dell'apparecchio attiva (surriscaldamento dell'elemento riscaldante o della protezione dell'apparecchio)	 Processo di raffreddamento
 Bassa tensione	 Standby
 Aumentare la temperatura	 Diminuire la temperatura
 Soffiante in funzione	 Campo che visualizza unità o informazioni per il menu di assistenza
 Campo che visualizza i valori nominali e reali. Le indicazioni vengono espresse in un segmento a quattro valori senza separatore decimale	

L'indicatore a barre mostra il regime del soffiante su 5 livelli. Contemporaneamente, appare l'indicazione in % (1 P-100 P)

 Regime del ventilatore 100 % max.	 Regime del ventilatore 1 % min.
--	---

Sostituzione dell'elemento riscaldante



La sostituzione dell'elemento riscaldante è **consentita esclusivamente** a personale qualificato o sotto il monitoraggio di quest'ultimo.

- ❶ Fare raffreddare l'apparecchio. MISTRAL SYSTEM si spegne automaticamente.
- ❷ Scollegare l'apparecchio dalla rete.
- ❸ Rimuovere le quattroviti di fissaggio (13).
- ❹ **Rimuovere il tubo dell'elemento riscaldante (4)**, il tubo di mica, la guarnizione e l'elemento riscaldante.
- ❺ Estrarre l'elemento riscaldante dall'imballaggio.
- ❻ Inserire l'elemento riscaldante, la guarnizione, il tubo di mica e il **tubo dell'elemento riscaldante (4)**.
- ❼ **Montare il tubo dell'elemento riscaldante (4)** applicando le quattroviti di fissaggio (13).
- ❽ Allacciare nuovamente l'apparecchio alla rete. Tensione nominale: quella indicata sull'apparecchio deve corrispondere alla tensione di rete.

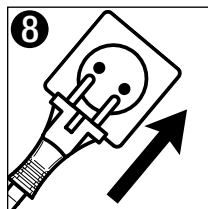
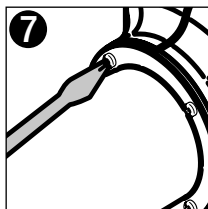
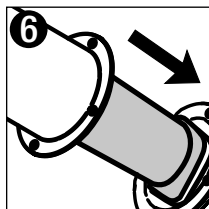
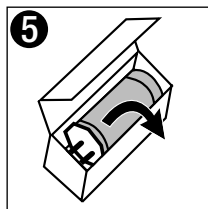
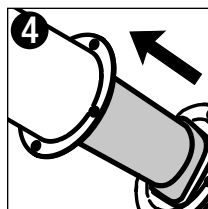
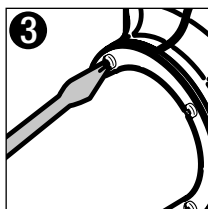
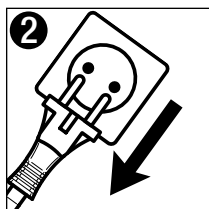
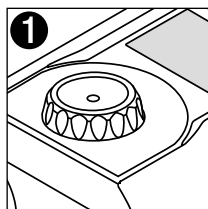

Protezione dell'elemento riscaldante e dell'apparecchio

Se l'elemento riscaldante o l'apparecchio si surriscaldano (temperatura dell'aria in entrata troppo elevata oppure riflusso caldo), l'alimentazione diretta all'elemento riscaldante viene interrotta. Nel MISTRAL SYSTEM viene aperto contemporaneamente il contatto NA del relè di allarme. Per ragioni di sicurezza relativamente alla protezione dell'elemento riscaldante o dell'apparecchio, è necessario osservare la seguente procedura di azzeramento dell'apparecchio.

PREMIUM	SYSTEM
A Disattivare l'emissione termica (impostare il potenziometro da 10 a 0)	A Fare raffreddare l'apparecchio
B Fare raffreddare l'apparecchio	B Scollegare l'apparecchio dalla rete
	C Dopo 10 sec., allacciare nuovamente l'apparecchio alla rete.
D Controllare le bocchette di aspirazione e scarico dell'aria e pulire se necessario.	

Specifiche degli ugelli bocchetta di scarico dell'aria

MISTRAL SYSTEM (tubo dell'elemento riscaldante \varnothing 36,5 mm)

Configurazione ugello	Tipo di ugello	Cod. art.	Bocchetta di scarico dell'aria (mm ²)
Load 0	-	-	380
Load 1	Ugello a fessura larga	108.078	400
Load 2	Ugello a fessura larga	107,261	280

Specifiche degli ugelli bocchetta di scarico dell'aria

MISTRAL SYSTEM (tubo dell'elemento riscaldante \varnothing 50 mm)

Configurazione ugello	Tipo di ugello	Cod. art.	Bocchetta di scarico dell'aria (mm ²)
Load 0	-	-	706
Load 1	Ugello a fessura larga	105,961	540
Load 2	Ugello a fessura larga	106,057	400

Uso del MISTRAL SYSTEM

Inserire l'alimentazione elettrica





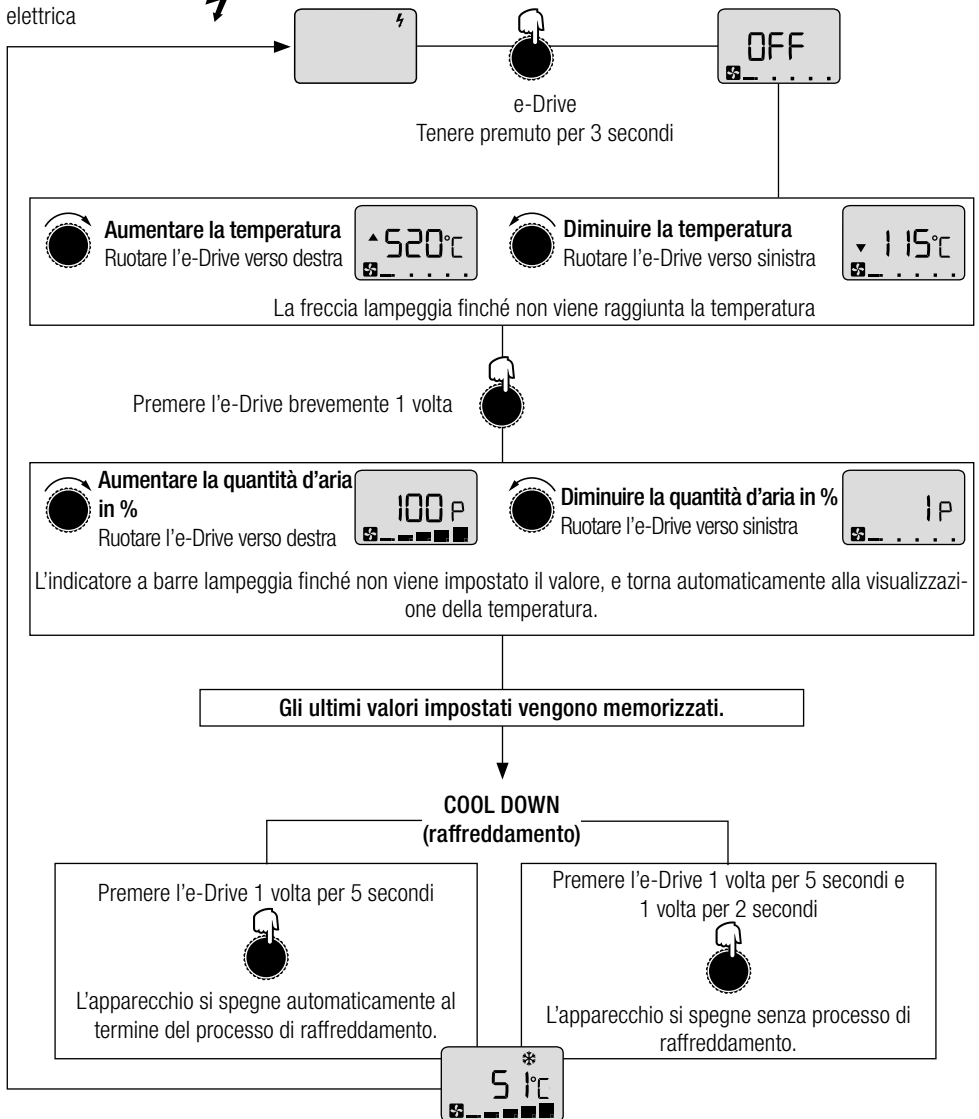

Modalità standby

Modalità di funzionamento



Menu di configurazione MISTRAL SYSTEM

e-Drive	Funzione	e-Drive	Funzione
	Breve pressione singola = attivazione		rotazione verso destra
	Pressione per 3 secondi = conferma		rotazione verso sinistra



Nota:

Se l'e-Drive viene premuto 1 volta brevemente senza confermare, i dati non verranno salvati.

Inserire l'alimentazione elettrica 

Modalità standby



per 3 secondi

Modalità di funzionamento



Menu Set-up

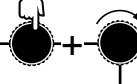

Premere per 2 secondi e, contemporaneamente, ruotare lentamente verso destra per 1/4 di giro

Unità di temperatura

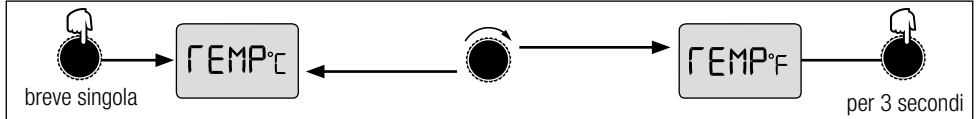

Limitazione temperatura 45 °C – 650 °C

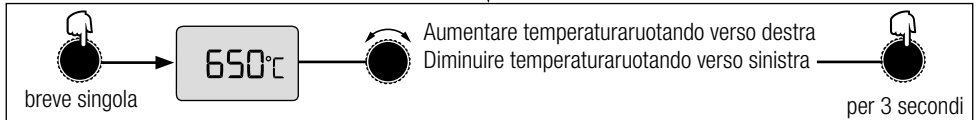

Indicazione interfaccia riscaldamento

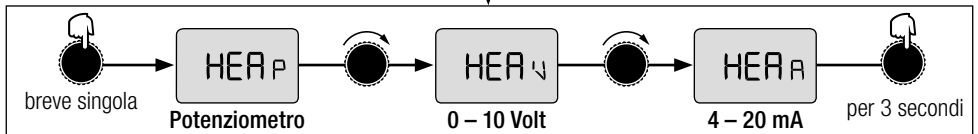

Pagina successiva

Menu di configurazione MISTRAL SYSTEM

Indicazione interfaccia ventilatore

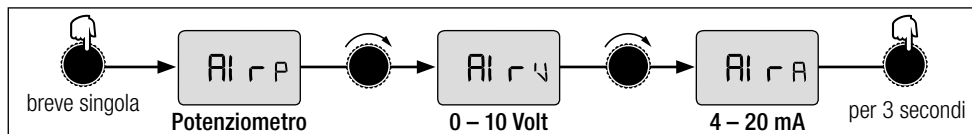

Controllato o regolato

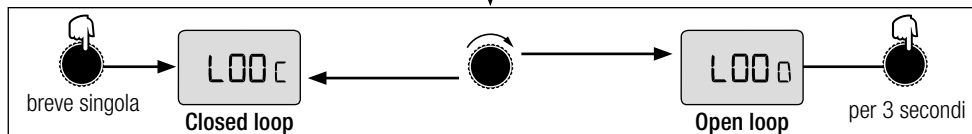

Configurazione ugello (vedere la tabella)

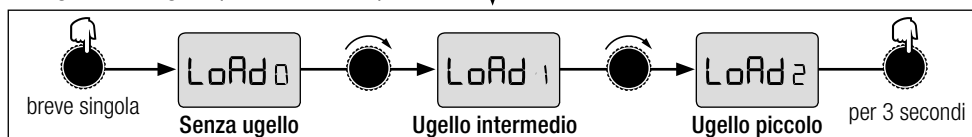

Scostamento termico +40°C / -40°C regolabile

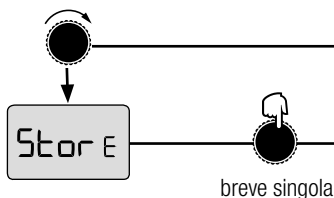
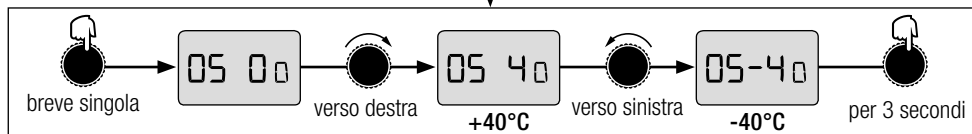









Le impostazioni vengono salvate. Ritorno alla modalità di funzionamento

OFF
S _

Indicazione	Descrizione	Indicazione	Descrizione
TEMP°C	Temperatura gradi Celsius	Al r A	Soffiante, indicazione interfaccia 4-20 mA
TEMP°F	Temperatura gradi Fahrenheit	L00 C	Controllo a circuito chiuso (closed loop)
HEA P	Riscaldamento e-Drive (potenziometro)	L00 O	Controllo a circuito aperto (open loop)
HEA V	Riscaldamento indicazione interfaccia 0-10 V	LoAd O	Parametri di regolazione senza ugello
HEA A	Riscaldamento indicazione interfaccia 4-20 mA	LoAd 1	Parametri di regolazione con ugello
Al r P	Soffiante, e-Drive (potenziometro)	LoAd 2	Parametri di regolazione ugello piccolo
Al r V	Soffiante, indicazione interfaccia 0-10 V	05-4 O	Impostazione scostamento termico +/-40 °C
		Stor E	Salvataggio

Messaggi di errore

Schermata	Descrizione	Causa errore	Soluzione
E001 	Termocoppia	Collegamento termocoppia	Controllare il collegamento della termocoppia
		Malfunzionamento della termocoppia	Contattare il centro di assistenza Leister
✖ E002 	Temperatura dell'elemento riscaldante troppo elevata	Guasto dell'elemento riscaldante	Sostituire l'elemento riscaldante (pag. 14)
		Presenza d'aria bloccata	Ispezionare la presa d'aria
		Filtro in lega d'acciaio bloccato	Pulire il filtro in lega d'acciaio
		Uscita aria bloccata	Ispezionare l'uscita aria
		Montato ugello errato	Sostituire l'ugello
		Definizione ugello errata	Verificare la definizione ugello (pag. 15)
⚡ E005 	Bassa tensione	Tensione di rete < 20% della tensione nominale	Verificare la tensione di rete
		Guasto dell'apparecchio	Contattare il centro di assistenza Leister
⚡ E008 	Temperatura apparecchio troppo elevata	La temperatura ambiente è maggiore rispetto a quella specificata	Ridurre la temperatura ambiente
		La temperatura dell'aria in entrata è maggiore rispetto a quella specificata	Ridurre la temperatura dell'aria in entrata
		Presenza d'aria bloccata	Ispezionare la presa d'aria
		Filtro in lega d'acciaio bloccato	Pulire il filtro in lega d'acciaio
		Uscita aria bloccata	Ispezionare l'uscita aria
		Montato ugello errato	Sostituire l'ugello
Definizione ugello errata	Verificare la definizione ugello (pag. 15)		
E003 	Contattare il centro di assistenza Leister		
E004 			
E006 			
E007 			
E009 			

Formazione

Leister Leister Technologies AG e i rispettivi centri d'assistenza autorizzati offrono corsi gratuiti nell'ambito delle applicazioni.

Disegni in 3D

I disegni in 3D dei riscaldatori ad aria della linea LHS sono disponibili presso il centro di servizio di assistenza tecnica o all'indirizzo www.leister.com.

Accessori

- Utilizzare esclusivamente accessori Leister.
- Leister offre una vasta gamma di accessori, tra cui:
 - regolatori di temperatura
 - ugelli
 - riflettori
 - potenziometri esterni
 - filtro
- Accessori disponibili alla pagina www.leister.com

Servizio di assistenza e riparazione

- Le riparazioni devono essere eseguite esclusivamente dai centri di assistenza tecnica Leister autorizzati. I centri di assistenza tecnica garantiscono un servizio di riparazione professionale ed affidabile con pezzi di ricambio originali conformi agli schemi elettrici e agli specifici elenchi.

Garanzia legale

- Per questo prodotto la garanzia legale è conforme alle disposizioni di legge vigenti nei singoli paesi, a partire dalla data di acquisto (faranno fede la fattura o la bolla di consegna). In caso di danni la garanzia prevede la fornitura sostitutiva o la riparazione. Gli elementi riscaldanti sono esclusi dalla garanzia.
- Si esclude ogni altro tipo di prestazione di garanzia che non sia prevista dalle disposizioni legali.
- La garanzia non copre eventuali danni conseguenti ad usura, carico eccessivo od uso improprio del prodotto. Si esclude ogni prestazione di garanzia in caso di danni dovuti a normale usura, a sovraccarico, oppure a trattamento ed impiego inappropriato.
- Non si accorda nessuna prestazione di garanzia in caso di macchine manomesse o modificate dal Cliente.

Istruzioni di sicurezza UL



Doppio isolamento - Durante la manutenzione utilizzare solo parti di ricambio identiche.
Attenzione: Scollegare dall'alimentazione prima di aprire questo coperchio.



Notice d'utilisation à lire attentivement avant la mise en service et à conserver pour consultation ultérieure.

Soufflerie à air chaud MISTRAL PREMIUM; SYSTEM

Application

La soufflerie à air chaud MISTRAL est conçue pour un montage dans des machines, des installations ou des appareils.

Ses principales applications sont par exemple le séchage et le chauffage, le dégivrage, l'accélération et la séparation, la stérilisation, le lissage, la brillance, l'activation et la dissolution, la séparation et la fusion, la thermorétraction, l'élimination.



Avertissement



Danger de mort en cas d'ouverture de l'appareil, en raison de l'exposition de composants et de connexions sous tension. Avant d'ouvrir l'appareil, celui-ci doit être déconnecté du réseau électrique sur tous les pôles.



Risque d'incendie et d'explosion en cas d'utilisation non conforme des souffleries à air chaud, surtout à proximité de matériaux inflammables et de gaz explosifs. Les zones dissimulées, telles que les plafonds, les sols, les panneaux de bordure de toit, les murs et autres éléments de ce type peuvent contenir des matériaux inflammables qui risquent de s'enflammer au contact de la chaleur dégagée par l'appareil à air chaud lors des interventions effectuées à ces emplacements. La combustion de ces matériaux peut ne pas être visible et risque d'entraîner des dégâts matériels et des blessures.



Risque de brûlure ! Ne pas toucher le tube de résistance ni la buse lorsqu'ils sont chauds. Laisser refroidir l'appareil. Ne pas diriger le flux d'air chaud sur des personnes ou des animaux.



Prudence



La tension nominale, indiquée sur l'appareil doit être identique à la tension du secteur. EN 61000-3-11/UL 499/CSA C22.2 No 88; $Z_{max} = 0,180 \Omega + j 0,113 \Omega$. Consulter le cas échéant les sociétés de distribution de l'électricité.



L'appareil **ne doit pas être utilisé sans surveillance**. La chaleur peut parvenir à des matériaux inflammables qui se trouvent hors de vue. L'appareil doit uniquement être utilisé par des **spécialistes qualifiés** ou sous leur surveillance. L'utilisation de l'appareil par des enfants est absolument interdite.



Pour usage à l'intérieur uniquement.

Recyclage



Les appareils électroniques, les accessoires et les emballages doivent être recyclés en respectant l'environnement. Veuillez respecter les réglementations nationales et locales en vigueur lors de l'élimination de nos produits. **Pour les pays de l'UE** : ne pas jeter les appareils électroniques avec les déchets ménagers.

Caractéristiques techniques MISTRAL

MISTRAL 2, 4, 6 PREMIUM		2	4	6	6	6	6	6
Tension	V~	230	120	120	230	230	230	220
Puissance	W	3400	2400	2400	2300	3400	4500	3100
Courant	A	15	20	20	10	15	20	14
Fréquence	Hz	50 / 60						60
Température à la sortie de l'air max., indéfinie	°C	520	490	430	500	510	650	510
Température d'entrée de l'air max.	°C	60						
Température d'entrée de l'air max.	°C	65						
Débit d'air max. (20 °C ambiant)	l/min.	350	300	350	300	350	400	350
Pression statique max.	kPa	3.5	3.5	2.5	2.5	2.5	3.0	2.5
Niveau d'émission	L _{pA} (dB)	65						
Poids	kg	1.4	1.4	1.4	1.2	1.4	1.5	1.4
Interface (pas libre de potentiel)		Potentiomètre externe de la puissance de chauffe						
Dimensions (cotes)		Page 3						
Label de conformité		CE						
Label de sécurité		Ⓢ			Ⓢ	c	UL	US
Classe de protection II		□						

MISTRAL 6 SYSTEM		6						
Tension	V~	100	120	200	230	230	230	220
Puissance	W	1500	2400	3000	2300	3400	4500	3100
Courant	A	15	20	15	10	15	20	14
Fréquence	Hz	50 / 60						60
Température à la sortie de l'air max., indéfinie	°C	650						
Température d'entrée de l'air max.	°C	60						
Température d'entrée de l'air max.	°C	65						
Débit d'air min. (consigne air 1 %)	l/min.	100	100	100	100	100	100	100
Débit d'air max. (consigne air 100 %)	l/min.	300	350	350	300	350	400	350
Pression statique max.	kPa	3.5	3.5	3.5	3.5	3.5	3.5	3.5
Niveau d'émission	L _{pA} (dB)	65						
Poids	kg	1.2	1.4	1.4	1.2	1.4	1.5	1.4
Interface (libre de potentiel)		4-20 mA et 0-10 V pour sortie d'alarme puissance de chauffe et débit d'air						
Dimensions (cotes)		Page 3						
Label de conformité		CE						
Label de sécurité		Ⓢ			Ⓢ	c	UL	US
Classe de protection II		□						

Sous réserve de modifications techniques

Caractéristiques techniques fonction de l'appareil

MISTRAL	PREMIUM	SYSTEM
Électronique de puissance intégrée	•	•
Protection contre la surchauffe de la résistance et de l'appareil	•	•
Sélecteur de codage intégré pour potentiomètre (interne/externe)	•	
Puissance de chauffe réglable en continu par potentiomètre	•	
Puissance de chauffe commutable séparément pour fonction Cool Down	•	
Display affichant les valeurs de consigne et les valeurs réelles (°C ou °F)		•
Température et débit d'air réglables en continu avec « e-drive »		•
Sonde thermique intégrée		•
Sortie d'alarme (contact relais)		•
Fonction Cool Down automatique		•
Limitation de la température réglable		•
Offset de température réglable		•
Interface de télécommande des consignes de température ou de puissance		•
Interface de télécommande de la consigne de débit d'air		•
Adaptation des paramètres de régulation sur 3 allures (buse ouverte, moyenne et petite)		•

Caractéristiques techniques interface

PREMIUM	Potentiomètre externe	Isolation	Pas libre de potentiel
		Résistance	10–100 kOhm
SYSTEM	Général	Isolation CEI/EN 60747-5-2	AC 1414 V _{peak}
		Protection contre l'inversion de polarité	
		Correction du point zéro	
	Entrées de tension	Tension 0–10 V	DC 0...10 V (ronflement < 0,07V avec résolution 5°C) ? (ronflement < 0,4V avec résolution 5%) ?
		Tension d'entrée max.	DC 12 V
		Résistance d'entrée nominale	33,7 kohm
	Entrées de courant	Courant 4–20 mA (technique 2 fils)	DC 4...20 mA (Rippel < 0,1 mA avec résolution 5°C) ? (Rippel < 0,7 mA avec résolution 5%) ?
		Courant d'entrée max.	DC 22 mA
		Résistance d'entrée nominale	159 ohms
	Sortie d'alarme (contact relais)	Tensions max.	AC 250 V, DC 30 V
		Courants max.	AC 3 A, DC 3 A
		Résistance de contact	100 mohm à DC 24 V / 1 A
		Type de contact	SPST-NO
		Isolation contact avec bobine	AC 4000V 1 min
Isolation contact avec contact		AC 1000V 1 min	

Modèles

MISTRAL	2 PREMIUM	4 PREMIUM	6 PREMIUM	6 SYSTEM
Moteur sans charbon			•	•
Moteur à charbon avec changement des charbons		•		
Moteur à charbon	•			

Caractéristiques techniques des fonctions

PREMIUM	Potentiomètre int. ou ext.	Puissance de chauffe	Consigne de puissance 0...100 % / OFF
SYSTEM	e-Drive ou interface	Température (closed Loop)	Consigne de température OFF, 50...650 °C; résolution 5 °C
		Température (open Loop)	Consigne de puissance OFF, 5...100 % ; résolution 5 %
		Débit d'air	Consigne de débit d'air 1, 5...100 % ; résolution 5 %

MISTRAL SYSTEM Schéma température / débit d'air

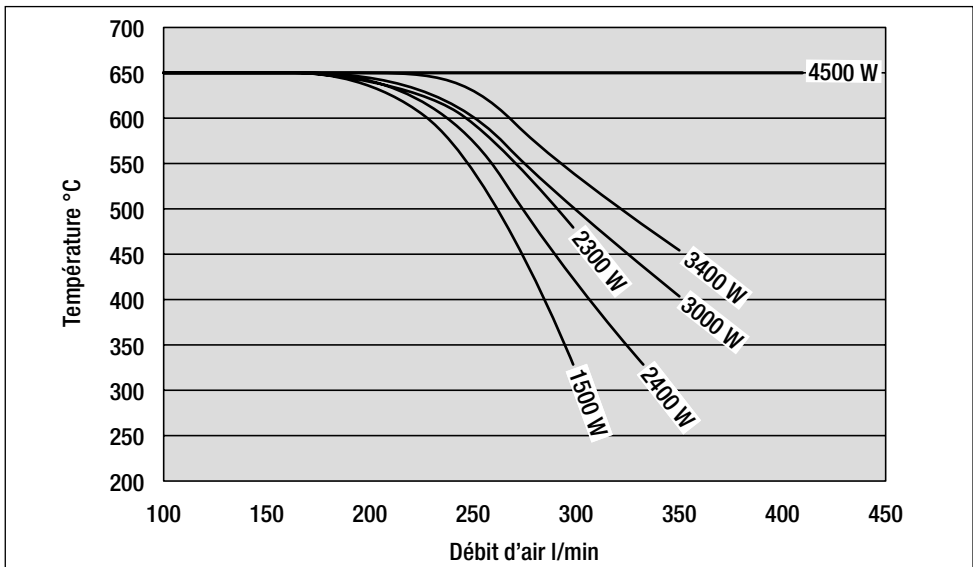

MISTRAL SYSTEM Interface / commande

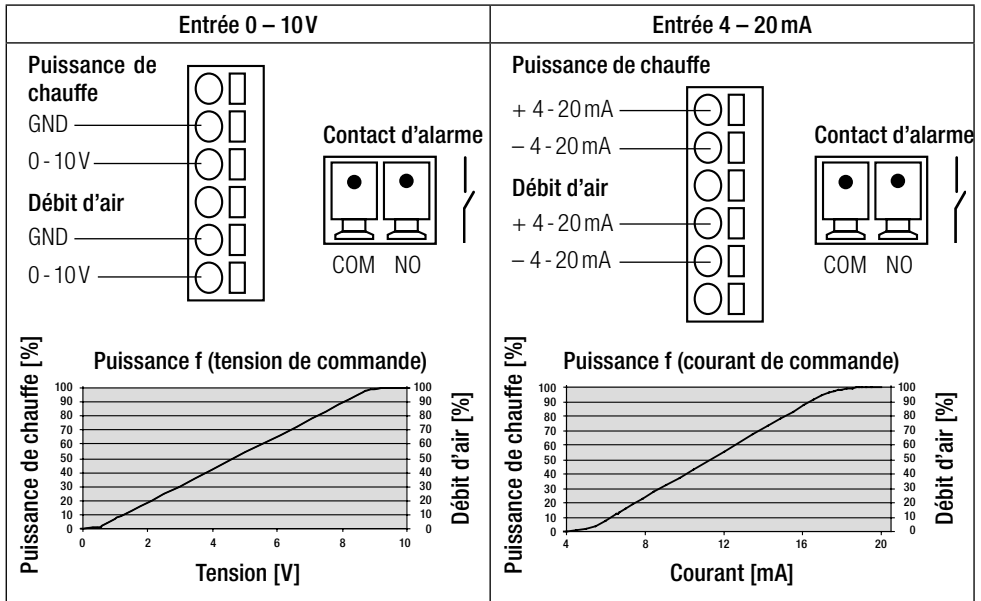

ATTENTION !

En cas d'incorporation de l'appareil, un dispositif adéquat doit être disponible dans le raccordement au secteur pour une **séparation omnipolaire** du secteur avec une distance de **contact d'au moins 3 mm**.

Description de l'appareil MISTRAL PREMIUM ; SYSTEM

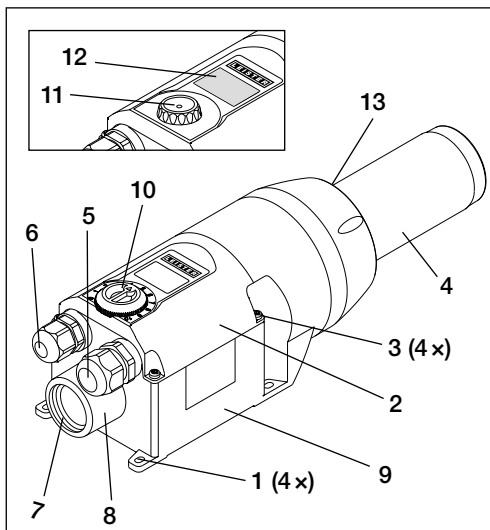

MISTRAL PREMIUM; SYSTEM

- 1 Éclisses de montage
- 2 Recouvrement du boîtier de raccordement
- 3 Vis du boîtier de raccordement
- 4 Tube de résistance
- 5 Raccord fileté pour la connexion au secteur
- 6 Raccord fileté de l'interface
- 7 Bride d'arrivée d'air avec filetage femelle G 1"
- 8 Raccord de \varnothing 38 pour tuyau d'air ou filtre en acier inoxydable
- 9 Boîtier de raccordement
- 13 Vis de fixation

MISTRAL PREMIUM

- 10 Potentiomètre de réglage de la puissance de chauffe

MISTRAL SYSTEM

- 11 e-Drive pour le réglage de la température / du débit d'air
- 12 Écran

Préparation MISTRAL PREMIUM ; SYSTEM

- Sortir le MISTRAL de l'emballage.
- Desserrer les **vis (3)** pour ouvrir **recouvrement du boîtier de raccordement (2)**.
- **Desserrer le raccord fileté du raccordement au secteur (5)**.
- Si nécessaire, desserrer le **raccord fileté de l'interface (6)**.

Montage

- Cet appareil ne doit être monté que par des spécialistes dûment formés.
- La température ambiante ne doit pas être supérieure à 65 °C
- Le montage doit garantir
 - que l'appareil ne sera alimenté qu'en air froid,
 - qu'il n'y aura pas d'accumulation de chaleur.
 - que l'appareil ne sera pas soumis au flux d'air chaud d'un autre appareil.
- Protéger le MISTRAL des vibrations mécaniques et des secousses.
- Fixer le MISTRAL au **éclisses de montage (1)** par quatre vis Ø M4.
- Éviter de positionnement l'appareil à la verticale. Si une position à la verticale ne peut être évitée, garantir le refroidissement de l'appareil – **risque de surchauffe**.
- Voir en page 3 (taille) pour les dimensions d'installation
- Si l'air est chargé de poussières, utilisez un filtre en acier inoxydable (voir Accessoires) au niveau de **raccord de ø 38 pour tuyau d'air ou filtre en acier inoxydable (8)**
- Si les poussières sont particulièrement critiques (par exemple poussières métalliques, électroconductrices ou humides), des filtres spéciaux doivent être utilisés pour éviter des courts-circuits dans l'appareil.



Les normes et directives locales applicables doivent toujours être respectées pendant l'installation (ex : directives en matière de prévention des incendies etc.).



Attention : toujours utiliser l'appareil avec une alimentation en air !

Raccordement

- Le MISTRAL doit être raccordé par des spécialistes.
- Dans le raccordement au secteur, un dispositif de coupure du réseau électrique omnipolaire doit être présent !
- Il doit être assuré que les câbles de raccordement ne pourront pas toucher le tube de la résistance et qu'ils ne seront pas soumis au flux d'air chaud.
- L'appareil doit être raccordé selon le schéma de raccordement et la disposition des bornes aux pages 4, 5, 6 (schéma de câblage) de la notice d'instructions :
 - Réaliser le câblage dans le **boîtier de raccordement (9)**.
- **ATTENTION** : Pour le MISTRAL PREMIUM, vérifier les réglages du sélecteur de codage (voir le schéma de câblage aux pages 4 ou 5).
- **Serrer le raccord fileté pour la connexion au secteur (5) et le raccord fileté de l'interface (6)** .
- **Monter le recouvrement du boîtier de raccordement (2) avec les vis (3)**.
- Raccorder le MISTRAL au secteur.
- Si besoin est, faire glisser la buse ou le réflecteur sur le **tube de la résistance (4)**.
- Il faut veiller à ce que l'air chaud circule librement, étant donné que l'appareil risquerait d'être détérioré en cas d'accumulation de chaleur (risque d'incendie !).
- Mettre sous tension.
- Régler le MISTRAL PREMIUM à la puissance de chauffe souhaitée avec le **potentiomètre (10)**.
- Régler le MISTRAL PREMIUM sur l'allure 0 avec le **potentiomètre (10)** et le laisser refroidir.
- Laisser refroidir le MISTRAL SYSTEM après fonctionnement à chaud.
- Les informations figurant dans le tableau suivant sont valables uniquement pour l'Amérique du Nord.
La certification UL sera caduque si un câble de raccordement incorrect est utilisé :

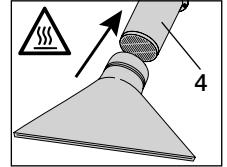

Courant nominal	≤ 10 A	≤ 12 A	≤ 13 A	≤ 16 A	≤ 18 A	≤ 21 A	≤ 25 A
Section minimale	18AWG	17AWG	16AWG	15AWG	14AWG	13AWG	12AWG

Changement de la buse / du réflecteur













Risque de brûlure ! Ne pas toucher le tube de résistance ni la buse lorsqu'ils sont chauds. Lorsque la buse ou le réflecteur doivent être changés, laisser refroidir l'appareil au préalable.



L'appareil doit être déconnecté du réseau électrique sur tous les pôles avant d'ouvrir le boîtier du potentiomètre externe.

Description du display MISTRAL SYSTEM

Symboles		Symboles	
	Résistance défectueuse		Contacter le service S.A.V. de Leister
	Protection de l'appareil activée (surchauffe de la résistance / de l'appareil)		Refroidissement
	Minima de tension		Standby
	Augmenter la température		Réduire la température
	Soufflerie active		Champ indicateur pour indiquer les unités ou des informations pour le menu Service
 Champ de valeur indiquant les valeurs de consigne et les valeurs réelles. Il s'agit d'un affichage à segment à quatre positions sans point décimal			

L'affichage à barres symbolise le régime de la soufflerie par 5 allures. L'affichage en % (1 P – 100 P) apparaît dans le même temps



Régime de la soufflerie 100 % max.



Régime de la soufflerie 1 % min.

Changement de la résistance



Le changement de résistance doit uniquement être réalisé par des **spécialistes qualifiés** ou sous leur surveillance.

- ❶ Laisser refroidir l'appareil. MISTRAL System se coupe automatiquement.
- ❷ Débrancher l'appareil du réseau électrique.
- ❸ Retirer les quatre **vis de fixation (13)**.
- ❹ **Retirer le tube de résistance (4)**, le tube Mica, le joint et la résistance.
- ❺ Sortir la résistance de son emballage.
- ❻ Insérer la résistance, le joint, le tube Mica et le **tube de résistance (4)**.
- ❼ **Monter le tube de résistance (4)** avec quatre **vis de fixation (13)**.
- ❽ Brancher l'appareil du réseau électrique. La tension nominale indiquée sur l'appareil doit être identique à la tension du secteur.

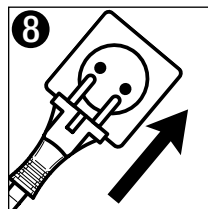
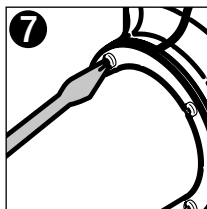
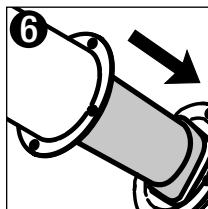
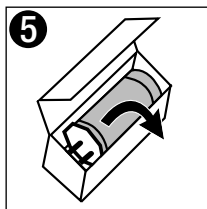
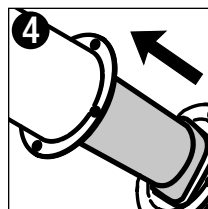
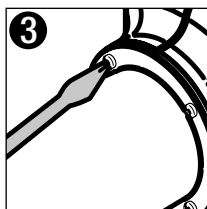
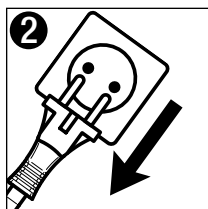
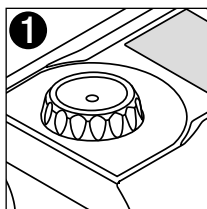

Fonction protection de la résistance et de l'appareil

L'alimentation électrique de la résistance est interrompue si la résistance ou l'appareil sont en surchauffe (température d'entrée d'air trop élevée ou accumulation de chaleur) Dans le cas du MISTRAL SYSTEM, le contact de travail du relais d'alarme s'ouvre parallèlement. Si la protection de la résistance ou de l'appareil réagissent, la procédure suivante pour remettre l'appareil en marche est à suivre pour des raisons de sécurité.

PREMIUM	SYSTEM
A Couper la puissance de chauffe (mettre le potentiomètre (10) sur 0)	A Laisser refroidir l'appareil
B Laisser refroidir l'appareil	B Débrancher l'appareil du réseau électrique
	C Rebrancher l'appareil au réseau électrique après 10 secondes.
D Contrôler les orifices d'entrée / de sortie d'air et les nettoyer au besoin.	

Définition des buses Orifice de sortie de l'air

MISTRAL SYSTEM (tube de résistance \varnothing 36,5 mm)

Réglage de buse	Type de buse	N° art.	Orifice de sortie de l'air (mm ²)
Load 0	-	-	380
Load 1	buse à large fente	108,078	400
Load 2	buse à large fente	107,261	280

Définition des buses Orifice de sortie de l'air

MISTRAL SYSTEM (tube de résistance \varnothing 50 mm)

Réglage de buse	Type de buse	N° art.	Orifice de sortie de l'air (mm ²)
Load 0	-	-	706
Load 1	buse à large fente	105,961	540
Load 2	buse à large fente	106,057	400

Commande de MISTRAL SYSTEM

Mettre sous tension 

Mode standby

Mode de service



e-Drive

Presser pendant 3 secondes



Augmenter la température

Tourner e-Drive vers la droite

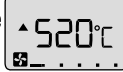

Réduire la température

Tourner e-Drive vers la gauche



La flèche clignote jusqu'à ce que la température soit atteinte

Presser e-Drive 1× brièvement



Augmenter le débit d'air en %

Tourner e-Drive vers la droite



Réduire le débit d'air en %

Tourner e-Drive vers la gauche



L'affichage à barre clignote jusqu'à ce que la valeur soit réglée et revient automatiquement à l'affichage de la température.

Les dernières valeurs réglées sont enregistrées.

COOL DOWN
(refroidir)

Presser e-Drive 1× pendant 5 secondes



L'appareil s'arrête automatiquement après la phase de refroidissement.



Presser e-Drive 1× pendant 5 secondes et 1× > 2 secondes

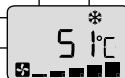

L'appareil s'arrête sans phase de refroidissement.



Configuration Menu Set-up MISTRAL SYSTEM

e-Drive	Fonction	e-Drive	Fonction
	Presser 1x brièvement = activer		Tourner vers la droite
	Presser 3 secondes = confirmer		Tourner vers la gauche



Indication :

si vous pressez e-Drive 1x brièvement sans confirmer, les valeurs ne seront pas enregistrées.

Mettre sous tension 

Mode standby



3 secondes

Mode de service



Menu Setup



Presser 2 secondes et tourner en même temps lentement vers la droite sur 1/4 de tour

Unité de température

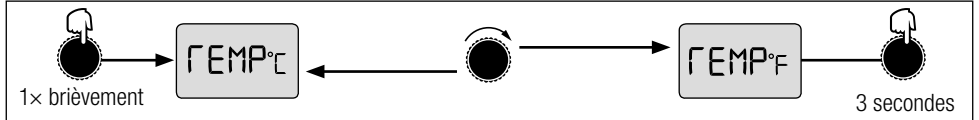

Limitation de température 45 °C – 650 °C

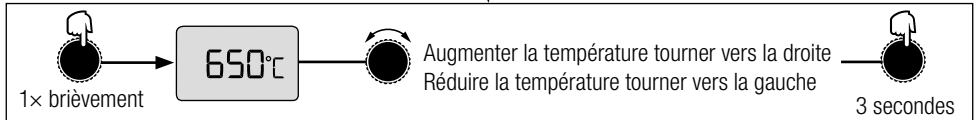

Chauffage consigne de l'interface

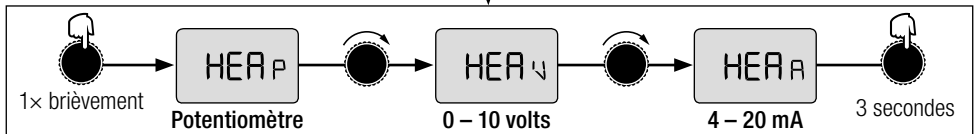

Page suivante

Configuration Menu Set-up MISTRAL SYSTEM

Soufflerie consigne d'interface

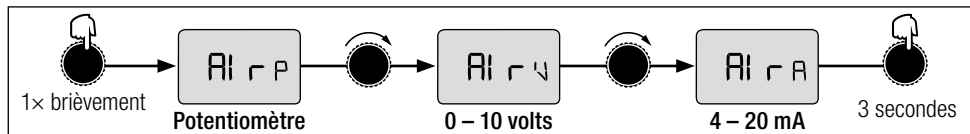

Piloté ou régulé

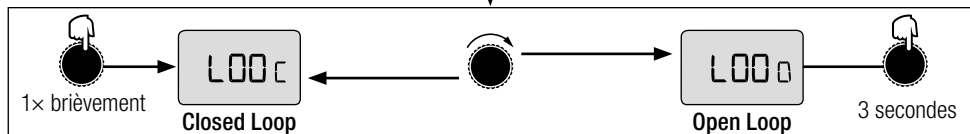

Réglage de buse (voir tableau)

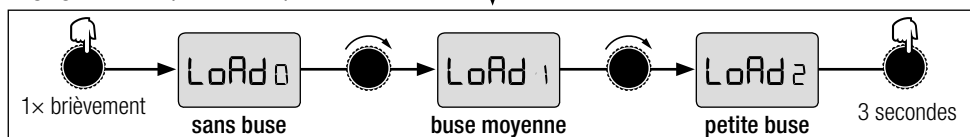

Offset de température réglable +40°C / -40°C

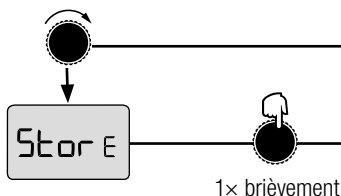
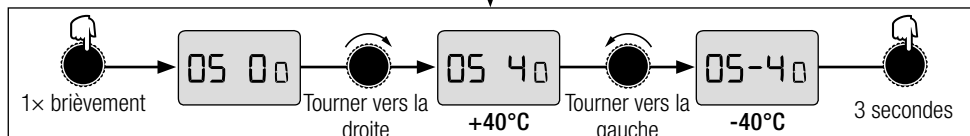









Les réglages sont enregistrés. Retour au mode de service

OFF
S _

Affichage	Description
TEMP°C	Température en degré Celsius
TEMP°F	Température en degré Fahrenheit
HEA P	Chauffage e-Drive (potentiomètre)
HEA V	Chauffage consigne de l'interface 0 – 10 V
HEA A	Chauffage consigne de l'interface 4 – 20 mA
Al r P	Soufflerie e-Drive (potentiomètre)
Al r V	Soufflerie consigne de l'interface 0 – 10 V

Affichage	Description
Al r A	Soufflerie consigne de l'interface 4 – 20 mA
L00 C	Régulation en Closed Loop
L00 □	Pilotage en Open Loop
LoAd □	Paramètres de régulation sans buse
LoAd 1	Paramètres de régulation avec buse moyenne
LoAd 2	Paramètres de régulation avec petite buse
05 -4 □	Réglage de l'offset de température +/- 40 °C
Stor E	Enregistrement

Messages d'erreur

Affichage	Désignation	Cause de l'erreur	Élimination de l'erreur
E001 	Thermocouple	Raccord du thermocouple	Contrôler le raccord du thermocouple
		Thermocouple défectueux	Contacteur le service S.A.V. de Leister
* E002 	Température résistance trop élevée	Résistance défectueuse	Remplacer la résistance (p. 14)
		Entrée d'air bloquée	Contrôler l'entrée d'air
		Filtre en acier inoxydable bloquée	Nettoyer le filtre en acier inoxydable
		Sortie d'air bloquée	Contrôler la sortie d'air
		Mauvaise buse montée	Changer la buse
		Mauvaise définition de buse	Contrôler la définition de buse (p. 15)
E005 	Minima de tension	Tension de secteur < 20 % de la tension nominale	Contrôler la tension de secteur
		Appareil défectueux	Contacteur le service S.A.V. de Leister
!!! E008 	Température de l'appareil trop élevée	Température ambiante plus importante que spécifié	Réduire la température ambiante
		Température de l'entrée d'air plus importante que spécifié	Réduire la température de l'entrée d'air
		Entrée d'air bloquée	Contrôler l'entrée d'air
		Filtre en acier inoxydable bloquée	Nettoyer le filtre en acier inoxydable
		Sortie d'air bloquée	Contrôler la sortie d'air
		Mauvaise buse montée	Changer la buse
		Mauvaise définition de buse	Contrôler la définition de buse (p. 15)
E003 	Contacter le service S.A.V. de Leister		
E004 			
E006 			
E007 			
E009 			

Formation

- Leister Technologies AG et ses SAV compétents proposent des cours et des formations gratuits.
- Informations à l'adresse www.leister.com.

Dessins 3D

- Les dessins 3D sont disponibles auprès de votre point service ou sur www.leister.com

Accessoires

- N'utiliser que des accessoires Leister.
- Leister propose un grand assortiment d'accessoires, comme
 - Régulateur de température
 - Buses
 - Réflecteurs
 - Potentiomètre externe
 - Filtre
- Pour les accessoires, voir www.leister.com

Maintenance et réparation

- Les réparations doivent être réalisées exclusivement par les SAV Leister compétents. Ils garantissent un service de réparation approprié et fiable, dans les délais prévus, avec des pièces détachées d'origine, conformément aux schémas de câblage et aux listes des pièces de rechange.

Garantie légale

- Pour cet appareil, une garantie selon les législations/règlementations locales en vigueur est toujours valable à partir de la date de l'achat (justificatif par facture ou bordereau de livraison). Une livraison de remplacement ou une réparation est assurée en cas de dommages sur l'appareil. Les éléments de chauffage ne sont pas couverts par cette garantie.
- Toute autre prétention est exclue sauf disposition légale contraire.
- Tout endommagement du à l'usure naturelle, à une surcharge de l'appareil ou à un maniement contraire aux prescriptions est exclu de la garantie
- La garantie ne s'applique pas aux appareils ayant subi des modifications apportées par l'acheteur ou l'utilisateur.

Consignes de sécurité UL



Double isolation – utiliser uniquement des pièces de rechange identiques lors des réparations.
Attention: Déconnecter de l'alimentation électrique avant d'ouvrir ce couvercle.



Lea detenidamente las instrucciones de servicio antes de la puesta en marcha y consérvelas para futuras consultas.

Soplador de aire caliente MISTRAL PREMIUM; SYSTEM

Aplicación

El soplador de aire caliente MISTRAL es adecuado para el montaje en máquinas, instalaciones o equipos.

Entre sus principales aplicaciones se encuentran el **secado y el calentamiento, el derretimiento, el acelerado y la solubilización, el esterilizado, el pulido, el abrillantamiento, el activado y la disolución, el deslaminado y el fundido, la contracción, la retirada.**



Advertencia



Peligro de muerte al abrir el equipo, ya que quedan al descubierto los componentes y conexiones conductores de tensión. Antes de abrir el equipo debe desconectarlo de la red en todos los polos.



Peligro de incendio y explosión en caso de uso inapropiado de dispositivos de aire caliente, especialmente en las inmediaciones de materiales inflamables y gases explosivos. Las áreas ocultas tales como techos, suelos, paneles de yeso, paredes y otros paneles pueden contener materiales inflamables que pueden prenderse con la pistola de calor al trabajar en estos lugares. La ignición de estos materiales puede no ser aparente y puede provocar daños materiales y lesiones personales.



Peligro de quemaduras. No toque el conducto del elemento de calefacción ni la tobera si están calientes. Deje que el equipo se enfríe. No apunte a personas ni a animales con el chorro de aire caliente.



Precaución



La tensión nominal especificada en el equipo debe coincidir con la tensión de alimentación. Impedancia máxima de la fuente $0.180 \Omega + j 0.113 \Omega$, de acuerdo con la especificación EN 61000-3-11/UL 499/CSA C22.2 no. 88 En caso de duda, se debe consultar con la compañía responsable de proveer electricidad.



El dispositivo **debe operarse con supervisión**. El calor puede alcanzar materiales inflamables que se encuentren fuera del campo visual. El equipo solo lo puede **manejar personal especializado formado** o personas que estén bajo su supervisión. Los niños no están autorizados a emplear el equipo bajo ningún concepto.



Para uso exclusivo en interiores.

Eliminación



Los equipos eléctricos, los accesorios y los embalajes deben reciclarse y reutilizarse de forma adecuada para proteger el medio ambiente. Por favor, tenga en cuenta las regulaciones nacionales y locales al desechar nuestros productos. **Para los países de la UE:** No desechar jamás equipos eléctricos en la basura doméstica.

Datos técnicos MISTRAL

MISTRAL 2, 4, 6 PREMIUM		2	4	6	6	6	6	6
Tensión	V~	230	120	120	230	230	230	220
Potencia	W	3400	2400	2400	2300	3400	4500	3100
Corriente	A	15	20	20	10	15	20	14
Frecuencia	Hz	50 / 60						60
Temperatura máx. de salida de aire, abierta	°C	520	490	430	500	510	650	510
Temperatura máxima de entrada de aire	°C	60						
Temperatura ambiente máx.	°C	65						
Flujo de aire máx. (20 °C ambiente)	l/min.	350	300	350	300	350	400	350
Presión estática máx.	kPa	3.5	3.5	2.5	2.5	2.5	3.0	2.5
Nivel de emisiones (dB)	L _{pA}	65						
Peso	kg	1.4	1.4	1.4	1.2	1.4	1.5	1.4
Interfaz (no libre de potencial)		Potenciómetro externo para la capacidad de calefacción						
Dimensiones (Size)		Página 3						
Marca de conformidad		CE						
Señal de seguridad		Ⓢ			Ⓢ	cULUS		Ⓢ
Clase de protección II		□						

MISTRAL 6 SYSTEM		6						
Tensión	V~	100	120	200	230	230	230	220
Potencia	W	1500	2400	3000	2300	3400	4500	3100
Corriente	A	15	20	15	10	15	20	14
Frecuencia	Hz	50 / 60						60
Temperatura máx. de salida de aire, abierta	°C	650						
Temperatura máxima de entrada de aire	°C	60						
Temperatura ambiente máx.	°C	65						
Flujo de aire mín. (valor nominal de aire 1 %)	l/min.	100	100	100	100	100	100	100
Flujo de aire máx. (valor nominal de aire 100 %)	l/min.	300	350	350	300	350	400	350
Presión estática máx.	kPa	3.5	3.5	3.5	3.5	3.5	3.5	3.5
Nivel de emisiones (dB)	L _{pA}	65						
Peso	kg	1.2	1.4	1.4	1.2	1.4	1.5	1.4
Interfaz (libre de potencial)		De 4 a 20 mA y de 0 a 10 V para capacidad de calefacción y flujo de aire de la salida de alarma						
Dimensiones (Size)		Página 3						
Marca de conformidad		CE						
Señal de seguridad		Ⓢ			Ⓢ	cULUS		Ⓢ
Clase de protección II		□						

Datos técnicos acerca del funcionamiento del equipo

MISTRAL	PREMIUM	SYSTEM
Electrónica de potencia integrada	•	•
Protección ante el sobrecalentamiento del equipo y el elemento de calefacción	•	•
Conmutador de codificación integrado para potenciómetro (interno/externo)	•	
Regulación continua de la capacidad de calefacción a través de potenciómetro	•	
Capacidad de calefacción separada cambiabile para función Cool Down	•	
Pantalla para la indicación de los valores teóricos o reales (°C o °F)		•
Temperatura y flujo de aire ajustables de forma continua mediante e-Drive		•
Sonda de temperatura integrada		•
Salida de alarma (contacto de relé)		•
Función Cool Down automática		•
Limitación ajustable de temperatura		•
Offset ajustable de temperatura		•
Interfaz de control remoto para especificaciones de temperatura o de potencia		•
Interfaz de control remoto para especificaciones de flujo de aire		•
Adaptación en 3 etapas del parámetro de regulación (tobera abierta, mediana y pequeña)		•

Datos técnicos Interfaz

PREMIUM	Externo Potenciómetro	Aislamiento	No libre de potencial
		Resistencia	10–100 kΩ
SYSTEM	General	Aislamiento IEC/EN 60747-5-2	CA 1414 V _{peak}
		Protección contra inversiones de polaridad	
		Corrección de punto cero	
	Entradas de tensión	Tensión 0–10V	CC 0...10V (Rippel < 0,07V con 5 °C resolución) (Rippel < 0,4V con 5% resolución)
		Tensión máx. de entrada	CC 12 V
		Resistencia de entrada nominal	33,7 kΩ
	Entradas de corriente	Corriente 4–20 mA (tecnología de 2 conductores)	CC 4...20 mA (Rippel < 0,1 mA con 5 °C resolución) (Rippel < 0,7 mA con 5% resolución)
		Corriente máx. de entrada	CC 22 mA
		Resistencia de entrada nominal	159 Ω
	Salida de alarma (contacto de relé)	Tensiones máximas	CA 250 V, CC 30 V
		Corrientes máximas	CA 3 A, CC 3 A
		Resistencia máxima de contacto	100 mΩ con CC 24 V/1 A
		Tipo de contacto	SPST-NO
		Contacto de aislamiento para bobina	CA 4000V 1 min.
Contacto de aislamiento para contacto		CA 1000V 1 min.	

Versiones

MISTRAL	2 PREMIUM	4 PREMIUM	6 PREMIUM	6 SYSTEM
Motor sin escobillas			•	•
Motor de escobillas con cambio de carbones		•		
Motor de escobillas	•			

Datos técnicos Funciones

PREMIUM	int. o ext. Potenciómetro	Capacidad de calefacción	Especificaciones de capacidad 0...100 % / OFF
SYSTEM	e-Drive o interfaz	Temperatura (closed Loop)	Especificaciones de temperatura OFF, 50...650 °C; 5 °C resolución
		Temperatura (open Loop)	Especificaciones de temperatura OFF, 5...100 %; 5 % resolución
		Flujo de aire	Especificaciones de flujo de aire 1, 5...100 %; 5 % resolución

MISTRAL SYSTEM Diagrama de temperatura/flujo de aire

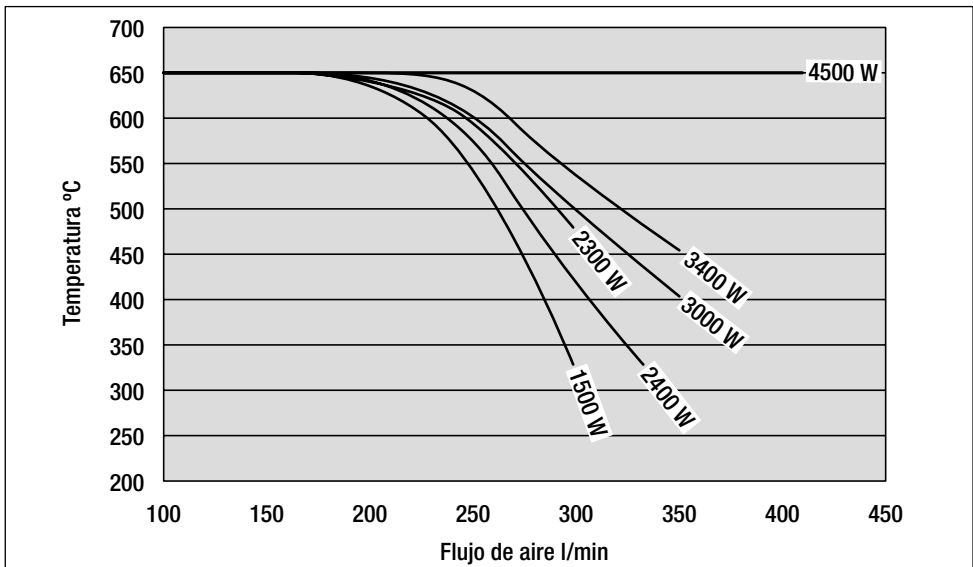

MISTRAL SYSTEM Interfaz/sistema de mando

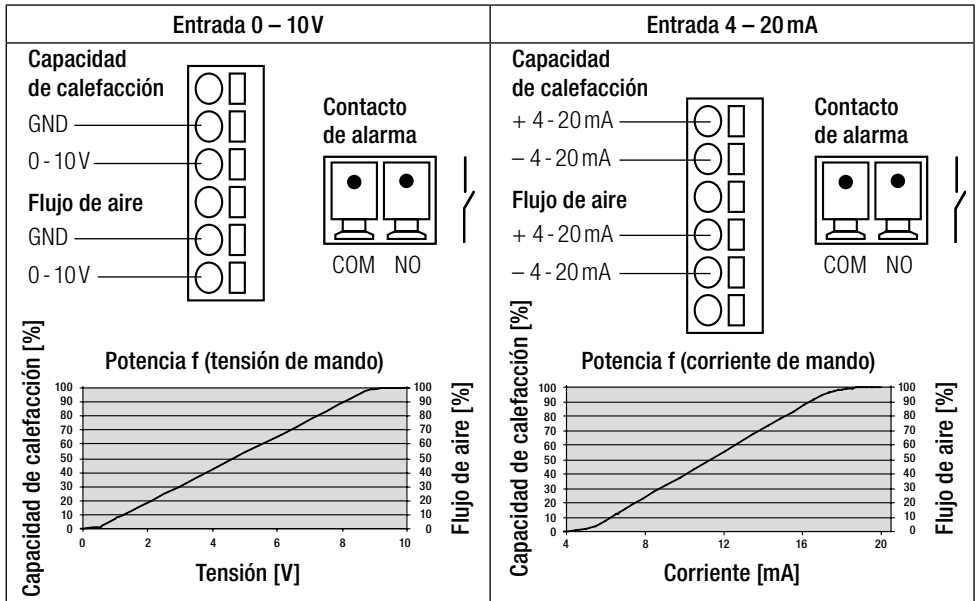

ATENCIÓN:

En caso de que se utilice como unidad incorporada, en la conexión debe haber un dispositivo **para la desconexión de todos los polos** de la red con una **distancia entre los contactos de 3 mm como mínimo**.

Descripción del equipo MISTRAL PREMIUM; SYSTEM

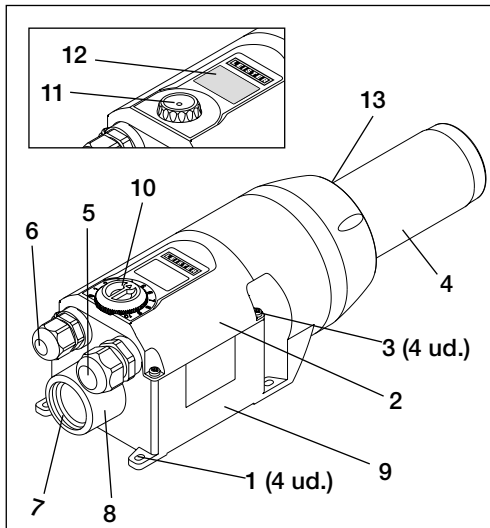

MISTRAL PREMIUM; SYSTEM

- 1 Lengüetas de montaje
- 2 Tapa de la caja de empalme
- 3 Tornillos para caja de empalme
- 4 Conducto del elemento de calefacción
- 5 Cable tipo racor para la conexión de red
- 6 Cable tipo racor para interfaz
- 7 Brida de entrada del aire con rosca interior G 1"
- 8 Conexión \varnothing 38 para manguera de aire o filtro de acero inoxidable
- 9 Caja de empalme
- 13 Tornillos de fijación

MISTRAL PREMIUM

- 10 Potenciómetro para el ajuste de la capacidad de calefacción

MISTRAL SYSTEM

- 11 e-Drive para ajuste de temperatura/flujo de aire
- 12 Pantalla

Preparación del equipo MISTRAL PREMIUM; SYSTEM

- Retirar MISTRAL del embalaje.
- Abrir la **tapa de la caja de empalme (2)** aflojando los tornillos (3).
- Aflojar el **cable tipo racor para la conexión de red (5)**.
- **Si fuera necesario, soltar el cable tipo racor para la interfaz (6).**

Montaje

- La instalación del equipo únicamente se autoriza a personal especializado con la debida formación.
- La temperatura ambiente no debe ser superior a 65 °C
- Dicha instalación deberá garantizar que:
 - la alimentación únicamente se produzca con aire frío.
 - no se produzca ninguna retención (ni estancamiento térmico).
 - el equipo no se someta al chorro de aire caliente de otro equipo.
- Protección de MISTRAL a prueba de vibraciones mecánicas y sacudidas.
- Fijación de MISTRAL con cuatro tornillos Ø M4 a las **lengüetas de montaje (1)**.
- Evitar el posicionamiento vertical del equipo. Si no se puede evitar el posicionamiento vertical, asegurar el enfriamiento del equipo. **Peligro de sobrecalentamiento.**
- Ver las dimensiones de instalación en la página 3 (Size)
- En caso de un alto contenido de polvo en el aire, utilice un filtro de acero inoxidable de Leister (consulte Accesorios) y colóquelo sobre la **Conexión ø 38 para manguera de aire o filtro de acero inoxidable (8)**
- En el caso de partículas especialmente problemáticas (de metal, conductoras de electricidad o húmedas) deberán utilizarse filtros especiales para evitar cortocircuitos en el aparato.



Durante la instalación siempre se debe seguir los estándares y recomendaciones locales que sean aplicables (p. ej. recomendaciones para la protección especial contra incendios, etc.).



Atención: Poner el equipo en marcha únicamente con el suministro de aire conectado.

Conexión

- Únicamente se autoriza la conexión de MISTRAL a personal especializado.
- El cable de alimentación principal deberá constar de un dispositivo adecuado para la desconexión de todos los polos de la red.
- Deberá garantizarse que los cables de conexión no entren en contacto con el conducto de la resistencia ni se expongan al chorro de aire caliente.
- El equipo deberá conectarse conforme al esquema de conexión y a la colocación de los terminales referidos en las páginas 4, 5, 6 (Wiring Diagram) de las instrucciones de uso:
 - Efectuar el cableado **de la caja de empalme (9)**.
- **ATENCIÓN:** Revisar la configuración del conmutador de codificación de MISTRAL PREMIUM (ver "Wiring Diagram" en la página 4 o 5).
- Tender el **cable tipo racor para la alimentación principal (5)** y el **cable tipo racor para la interfaz (6)**.
- Montar la **tapa de la caja de empalme (2)** con los **tornillos (3)**.
- Conectar MISTRAL a la red eléctrica.
- Si fuera necesario, deslizar la tobera o el reflector correspondiente sobre el **conducto de del elemento de calefacción (4)**.
- Debe tenerse en cuenta que el flujo de aire caliente no se vea obstaculizado, ya que, de lo contrario, el equipo podría sufrir daños debido a un estancamiento del calor (riesgo de incendio).
- Conectar la red.
- Regular la capacidad de calefacción de MISTRAL PREMIUM deseada con el **potenciómetro (10)**.
- Llevar MISTRAL PREMIUM al nivel 0 con el **potenciómetro (10)** y dejar que se enfríe.
- Dejar enfriar el MISTRAL SYSTEM tras el funcionamiento de la calefacción.
- La información de la siguiente tabla es solo relevante para Norteamérica. La certificación UL queda invalidada si se utiliza el cable de conexión incorrecto:

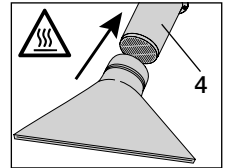

Corriente nominal	≤ 10 A	≤ 12 A	≤ 13 A	≤ 16 A	≤ 18 A	≤ 21 A	≤ 25 A
Sección transversal mínima	18 AWG	17 AWG	16 AWG	15 AWG	14 AWG	13 AWG	12 AWG

Cambio de la tobera/el reflector













Peligro de quemaduras. No toque el conducto del elemento de calefacción ni la tobera si están calientes. Antes de cambiar la tobera o el reflector, dejar enfriar el equipo.



Antes de abrir la carcasa externa del potenciómetro debe desconectar el equipo de la red en todos los polos.

Descripción de la pantalla MISTRAL SYSTEM

Símbolos	Símbolos
 Elemento de calefacción averiado	 Ponerse en contacto con el servicio técnico de Leister
 Protección del equipo activada (Sobrecalentamiento del elemento de calefacción/protección del equipo)	 Procedimiento de enfriamiento
 Subtensión	 Standby
 Aumentar la temperatura	 Reducir la temperatura
 Soplador activado	 Campo del indicador para la representación de unidades o información para el menú de servicio
 Cuadro de valor para la representación de los valores teóricos y reales. Se trata de un indicador de cuatro segmentos sin punto decimal	

El diagrama de barras representa las revoluciones del soplador en 5 etapas. Al mismo tiempo, aparece la indicación en % (1 P–100 P)



Cambio del elemento de calefacción



El cambio del elemento de calefacción solo puede **realizarlo personal especializado formado** o personas que estén bajo su supervisión.

- ❶ Dejar enfriar el equipo. El sistema MISTRAL se desconecta automáticamente.
- ❷ Desconectar el equipo de la red eléctrica.
- ❸ Retirar los cuatro **torillos de fijación (13)**.
- ❹ **Retirar el conducto del elemento de calefacción (4)**, el Mica Tube, la junta y el elemento de calefacción.
- ❺ Sacar el elemento de calefacción del embalaje.
- ❻ Colocar el elemento de calefacción, la junta, el Mica Tube y **el conducto del elemento de calefacción (4)**.
- ❼ **Montar el tubo de elemento de calefacción (4)** con cuatro **torillos de fijación (13)**.
- ❽ Conectar el equipo a la red eléctrica. La tensión nominal indicada en el equipo debe coincidir con la tensión de red.

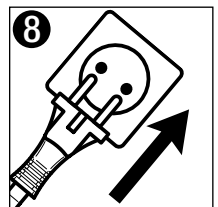
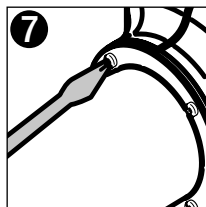
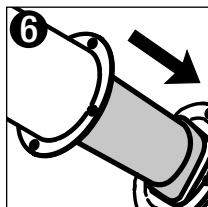
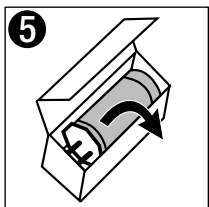
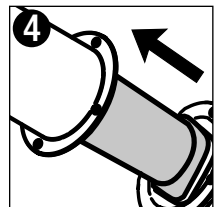
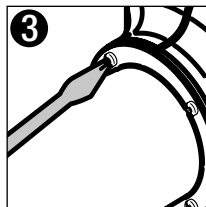
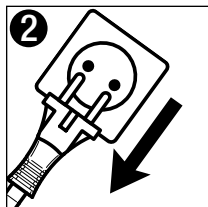
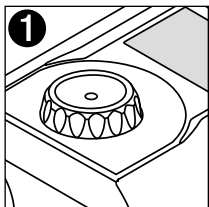

Función Protección de elemento de calefacción y del equipo

Si se sobrecalienta el elemento de calefacción o el equipo (temperatura de la salida de aire muy elevada o retención de calor), se interrumpe el aporte de potencia al elemento de calefacción. En el MISTRAL SYSTEM se abre al mismo tiempo el contacto de alarma del relé de alarma. Si se quema la protección del elemento de calefacción o la protección del equipo, deben tenerse en cuenta los siguientes pasos para el reinicio del equipo por motivos de seguridad.

PREMIUM	SYSTEM
A Desconectar la capacidad de calefacción (poner el potenciómetro (10) a 0) B Dejar enfriar el equipo	A Dejar enfriar el equipo B Desconectar el equipo de la red C Volver a conectar el equipo a la red eléctrica transcurridos 10 s.
D Comprobar el orificio de entrada/salida de aire y limpiarlo si fuese necesario.	

Definición de tobera orificio de salida de aire

MISTRAL SYSTEM (conducto del elemento de calefacción \varnothing 36,5 mm)

Ajuste de tobera	Tipo de tobera	N.º art.	Orificio de salida de aire (mm ²)
Load 0	-	-	380
Load 1	Tobera de ranura ancha	108,078	400
Load 2	Tobera de ranura ancha	107,261	280

Definición de tobera orificio de salida de aire

MISTRAL SYSTEM (conducto del elemento de calefacción \varnothing 50 mm)

Ajuste de tobera	Tipo de tobera	N.º art.	Orificio de salida de aire (mm ²)
Load 0	-	-	706
Load 1	Tobera de ranura ancha	105,961	540
Load 2	Tobera de ranura ancha	106,057	400

Manejo de MISTRAL SYSTEM

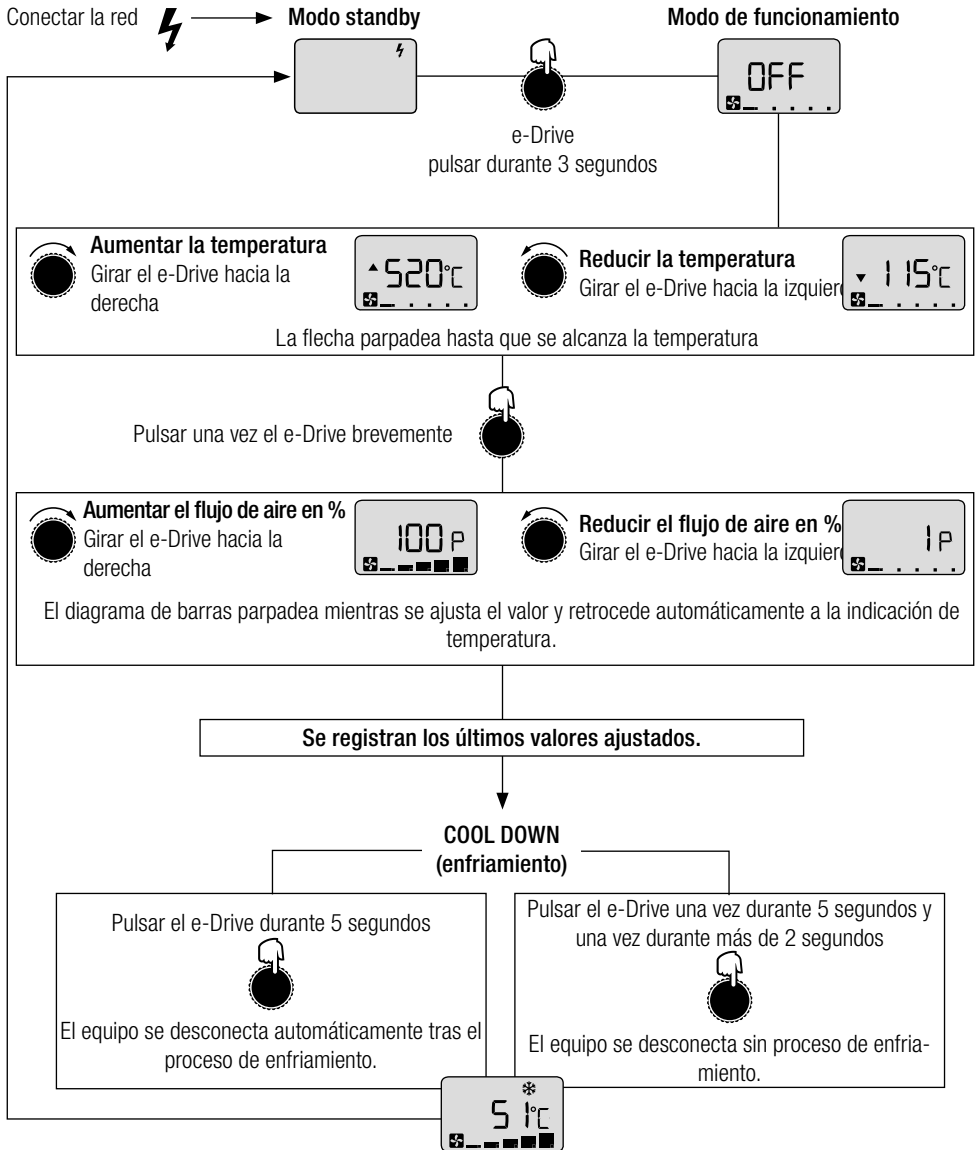

Configuración del menú setup MISTRAL SYSTEM

e-Drive	Función	e-Drive	Función
	pulsar una vez brevemente = activación		girar hacia la derecha
	pulsar durante 3 segundos = confirmación		girar hacia la izquierda



Indicación:

Si el e-Drive se pulsa brevemente una vez sin confirmación, los valores no se registran.

Conectar la red 

Modo standby



3 segundos

Modo de funcionamiento



Menú setup

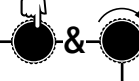

Pulsar 2 segundos y, al mismo tiempo, girar lentamente 1/4 de vuelta hacia la derecha

Unidad de temperatura

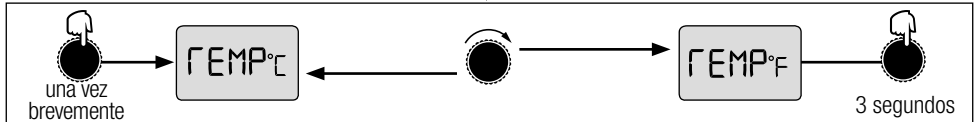

Limitación de temperatura 45 °C – 650 °C

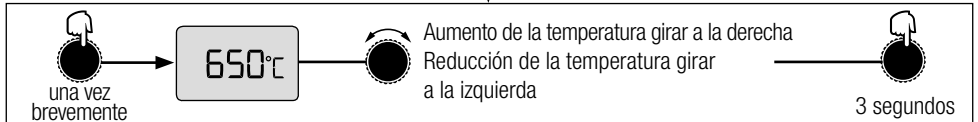

Especificación de la interfaz de calefacción

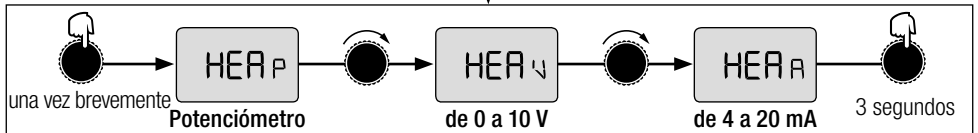

Página siguiente

Configuración del menú setup MISTRAL SYSTEM

Especificación de la interfaz del soplador

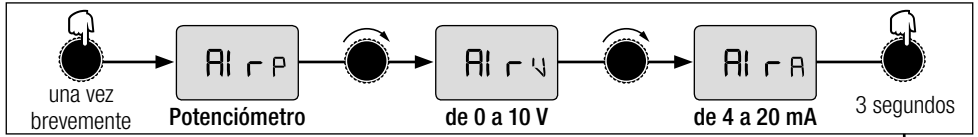

Controlado o regulado

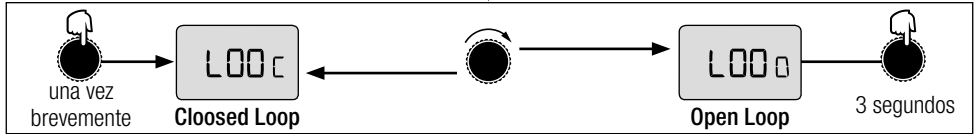

Ajuste de tobera (ver tabla)

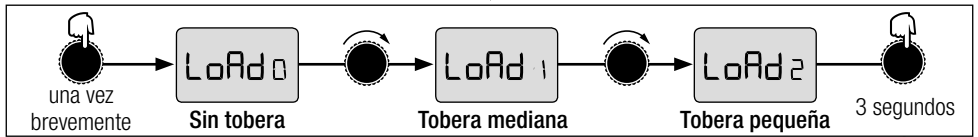

Offset de temperatura ajustable +40 °C/-40 °C

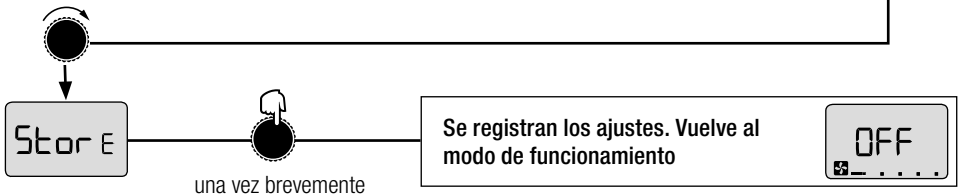
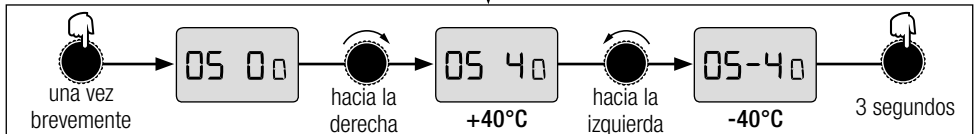

Indicación	descripción	Indicación	descripción
TEMP°C	Temperatura en grados Celsius	Al r A	Especificación de la interfaz del soplador de 4 a 20 mA
TEMP°F	Temperatura en grados Fahrenheit	L00 c	Closed Loop regulado
HEA P	Calefacción e-Drive (potenciometro)	L00 o	Open Loop controlado
HEA V	Especificación de la interfaz de calefacción de 0 a 10 V	LoAd o	Parámetro de regulación sin tobera
HEA A	Especificación de la interfaz de calefacción de 4 a 20 mA	LoAd 1	Parámetro de regulación de tobera mediana
Al r P	Soplador e-Drive (potenciometro)	LoAd 2	Parámetro de regulación de tobera pequeña
Al r V	Especificación de la interfaz del soplador de 0 a 10 V	05 -4 o	Ajuste de temperatura offset +/-40 °C
		Stor E	Guardar

Mensajes de error

Indicación	Denominación	Causa del error	Corrección del error
E001 c	Elemento térmico	Conexión del elemento térmico	Controlar la conexión del elemento térmico
		Elemento térmico defectuoso	Ponerse en contacto con el servicio técnico de Leister
* E002 c	Temperatura de la resistencia demasiado elevada	Resistencia averiada	Sustituir resistencia (p. 14)
		Entrada de aire bloqueada	Comprobar entrada de aire
		Filtro de acero inoxidable bloqueado	Limpiar filtro de acero inoxidable
		Salida de aire bloqueada	Comprobar salida de aire
		Tobera incorrecta montada	Cambiar tobera
		Definición de tobera incorrecta	Comprobar definición de tobera (p. 15)
E005 c	Subtensión	Tensión de red < 20 % de la tensión nominal	Comprobar tensión de red
		Equipo defectuoso	Ponerse en contacto con el servicio técnico de Leister
E008 c	Temperatura del equipo demasiado elevada	Temperatura ambiente superior a lo especificado	Reducir temperatura ambiente
		Temperatura de entrada de aire superior a lo especificado	Reducir temperatura de entrada de aire
		Entrada de aire bloqueada	Comprobar entrada de aire
		Filtro de acero inoxidable bloqueado	Limpiar filtro de acero inoxidable
		Salida de aire bloqueada	Comprobar salida de aire
		Tobera incorrecta montada	Cambiar tobera
		Definición de tobera incorrecta	Comprobar definición de tobera (p. 15)
E003 c	Ponerse en contacto con el servicio técnico de Leister		
E004 c			
E006 c			
E007 c			
E009 c			

Formación

- Leister Technologies AG y sus sucursales de servicio autorizadas ofrecen de forma gratuita cursos y formación sobre soldadura. Encontrará información en www.leister.com.

Diseños en 3D

- Podrá solicitar los esquemas en 3D al punto de servicio o encontrarlos en www.leister.com.

Accesorios

- Únicamente se podrán emplear accesorios de Leister.
- Leister ofrece un gran variedad de accesorios, p. ej.
 - Reguladores de temperatura
 - Toberas
 - Reflectores
 - Potenciómetro externo
 - Filtro
- Accesorios en www.leister.com

Servicio y reparaciones

- Las reparaciones se realizarán únicamente en puntos de servicio técnico autorizados por Leister. Éstos garantizan un servicio de reparación fiable y especializado en un plazo adecuado con piezas de repuesto originales conforme a los planos de conexiones y las listas de piezas de repuesto.

Garantía

- Para este aparato concedemos una garantía a partir de la fecha de compra (comprobación mediante factura o albarán de entrega) según las disposiciones legales específicas de cada país. Los daños que se produzcan se eliminarán mediante reparación o envío de sustitución. Los elementos calentadores no se incluyen en esta garantía.
- Quedan excluidas las reclamaciones de otro tipo, salvo aquellas que la ley prescriba.
- No quedan cubiertos por la garantía los daños ocasionados por desgaste natural, sobrecarga o manejo inadecuado.
- Asimismo se declina cualquier reclamación para aquellos aparatos que hayan sido transformados o alterados respecto a su estado original de suministro.

Instrucciones de seguridad UL



Doble aislamiento: al darle mantenimiento use solo partes de remplazo idénticas.
Precaución: Desconecte de la fuente de alimentación antes de abrir esta cubierta



Antes da colocação em funcionamento, leia atentamente o manual de instruções e guarde-o para futuras consultas.

Ventilador de ar quente MISTRAL PREMIUM; SYSTEM

Utilização

O ventilador de ar quente MISTRAL é adequado para montagem em máquinas, instalações ou equipamentos. **Suas principais utilizações são, por exemplo, secagem e aquecimento, descongelamento, aceleração e desintegração, esterilização, alisamento, polimento, ativação e dissolução, separação e fusão, contração, remoção.**



Aviso



Perigo de vida ao abrir o equipamento, caso os componentes e as conexões sob tensão fiquem expostos. Antes de abrir o equipamento, todos os polos deste devem ser desconectados da rede.



Perigo de incêndio e explosão em caso de uso incorreto de equipamentos de ar quente, particularmente nas proximidades de materiais inflamáveis e gases explosivos. As áreas ocultas, como tetos, pisos, painéis de revestimento (soffit), paredes e outros painéis podem conter materiais inflamáveis sujeitos a ignição por pistolas de ar quente durante o trabalho nesses locais. A ignição desses materiais pode não ser aparente e pode resultar em danos materiais e ferimentos a pessoas.



Perigo de queimadura! Não tocar no tubo do elemento de aquecimento e no bico se eles estiverem quentes. Deixar o aparelho resfriar. Não direcionar o jato de ar quente para pessoas ou animais.



Cuidado



A tensão nominal especificada no dispositivo deve corresponder à tensão de alimentação. Impedância de alimentação máxima $0,180 \Omega + j 0,113 \Omega$, de acordo com EN 61000-3-11 / UL 499 / CSA C22.2 no. 88 Em caso de dúvida, consulte a empresa fornecedora de energia elétrica responsável.



O aparelho **deve ser operado** sob supervisão. O calor pode atingir materiais inflamáveis que estão fora do alcance visual. O aparelho deve ser utilizado somente por **profissionais treinados** ou sob supervisão deles. A utilização por crianças é totalmente proibida.



Apenas para uso em ambiente fechado.

Descarte



Equipamentos elétricos, acessórios e embalagens devem ser conduzidos para uma reciclagem compatível com o ambiente. Por favor, observe os regulamentos nacionais e locais ao eliminar os nossos produtos. **Para os países da UE:** Não jogue equipamentos elétricos no lixo doméstico.

Dados técnicos MISTRAL

MISTRAL 2, 4, 6 PREMIUM		2	4	6	6	6	6	6
Tensão	V~	230	120	120	230	230	230	220
Potência	W	3400	2400	2400	2300	3400	4500	3100
Corrente	A	15	20	20	10	15	20	14
Frequência	Hz	50 / 60						60
Temperatura máx. da saída de ar, à discrição	°C	520	490	430	500	510	650	510
Temperatura máx. de entrada do ar	°C	60						
Temperatura ambiente máx.	°C	65						
Volume máx. de ar (ambiente 20°C)	l/min	350	300	350	300	350	400	350
Pressão estática máx.	kPa	3.5	3.5	2.5	2.5	2.5	3.0	2.5
Nível de emissões	L _{pA} (dB)	65						
Peso	kg	1.4	1.4	1.4	1.2	1.4	1.5	1.4
Interface (não sem potencial)		Potenciômetro externo para potência de aquecimento						
Dimensões (tamanho)		Página 3						
Marca de conformidade		CE						
Marca de segurança		Ⓢ	Ⓢ c RU US				Ⓢ Ⓜ	
Classe de proteção II		□						

MISTRAL 6 SYSTEM		6						
Tensão	V~	100	120	200	230	230	230	220
Potência	W	1500	2400	3000	2300	3400	4500	3100
Corrente	A	15	20	15	10	15	20	14
Frequência	Hz	50 / 60						60
Temperatura máx. da saída de ar, à discrição	°C	650						
Temperatura máx. de entrada do ar	°C	60						
Temperatura ambiente máx.	°C	65						
Volume mín. de ar (valor nominal do ar 1%)	l/min	100	100	100	100	100	100	100
Volume máx. de ar (valor nominal do ar 100%)	l/min	300	350	350	300	350	400	350
Pressão estática máx.	kPa	3.5	3.5	3.5	3.5	3.5	3.5	3.5
Nível de emissões	L _{pA} (dB)	65						
Peso	kg	1.2	1.4	1.4	1.2	1.4	1.5	1.4
Interface (sem potencial)		4-20mA e 0-10V para saída de alarme de potência de aquecimento e volume de ar						
Dimensões (tamanho)		Página 3						
Marca de conformidade		CE						
Marca de segurança		Ⓢ	Ⓢ c RU US				Ⓢ Ⓜ	
Classe de proteção II		□						

Dados técnicos Funcionamento do aparelho

MISTRAL	PREMIUM	SYSTEM
Eletrônica de potência integrada	•	•
Proteção contra superaquecimento do elemento de aquecimento e do aparelho	•	•
Interruptor de codificação integrado para potenciômetro (interno/externo)	•	
Potência de aquecimento com potenciômetro continuamente ajustável	•	
Potência de aquecimento comutável separadamente para função Cool Down	•	
Display para exibição dos valores nominais ou reais (°C ou °F)		•
Temperatura e fluxo de ar com e-drive continuamente ajustável		•
Sonda de temperatura integrada		•
Saída de alarme (contato de relé)		•
Função Cool Down automática		•
Limite ajustável de temperatura		•
Deslocamento ajustável de temperatura		•
Interface de controle remoto para especificação de temperatura ou de potência		•
Interface de controle remoto para especificação de volume de ar		•
Ajuste dos parâmetros de regulação em 3 níveis (bico aberto, médio e pequeno)		•

Dados técnicos Interface

PREMIUM	Potenciômetro externo	Isolamento	Não sem potencial
		Resistência	10 – 100 kOhm
SYSTEM	Geral	Isolamento IEC/EN 60747-5-2	CA 1414 Vpico
		Proteção contra inversão de polaridade	
		Correção do ponto zero	
	Entradas de tensão	Tensão 0 – 10 V	CC 0...10 V (ondulação < 0,07V com resolução de 5°C) (ondulação < 0,4V com resolução de 5%)
		Tensão máx. de entrada	CC 12V
		Resistência nominal de entrada	33,7kOhm
	Entradas de corrente	Corrente 4 – 20 mA (tecnologia de 2 condutores)	CC 4...20 mA (ondulação < 0,1mA com resolução de 5°C) (ondulação < 0,7mA com resolução de 5%)
		Corrente máx. de entrada	CC 22 mA
		Resistência nominal de entrada	159 Ohm
	Saída de alarme (contato de relé)	Tensões máx.	CA 250V, CC 30V
		Correntes máx.	CA 3A, CC 3A
		Resistência máx. de contato	100 mOhm em CC 24V/1 A
		Tipo de contato	Um polo, uma posição - NA
Isolamento contato para bobina		CA 4000 V 1 min	
Isolamento contato para contato		CA 1000 V 1 min	

Modelos

MISTRAL	2 PREMIUM	4 PREMIUM	6 PREMIUM	6 SYSTEM
Motor sem escovas			•	•
Motor com escovas com troca de carvão		•		
Motor com escovas	•			

Dados técnicos Funções

PREMIUM	Potenciômetro int. ou ext.	Potência de aquecimento	Especificação de potência 0...100% / DESLIGADO
SYSTEM	e-drive ou interface	Temperatura (circuito fechado)	Especificação de temperatura DESLIGADO, 50...650 °C; resolução de 5 °C
		Temperatura (circuito aberto)	Especificação de potência DESLIGADO, 5...100%; resolução de 5%
		Volume de ar	Especificação de volume de ar 1, 5...100%; resolução de 5%

MISTRAL SYSTEM Diagrama temperatura / volume de ar

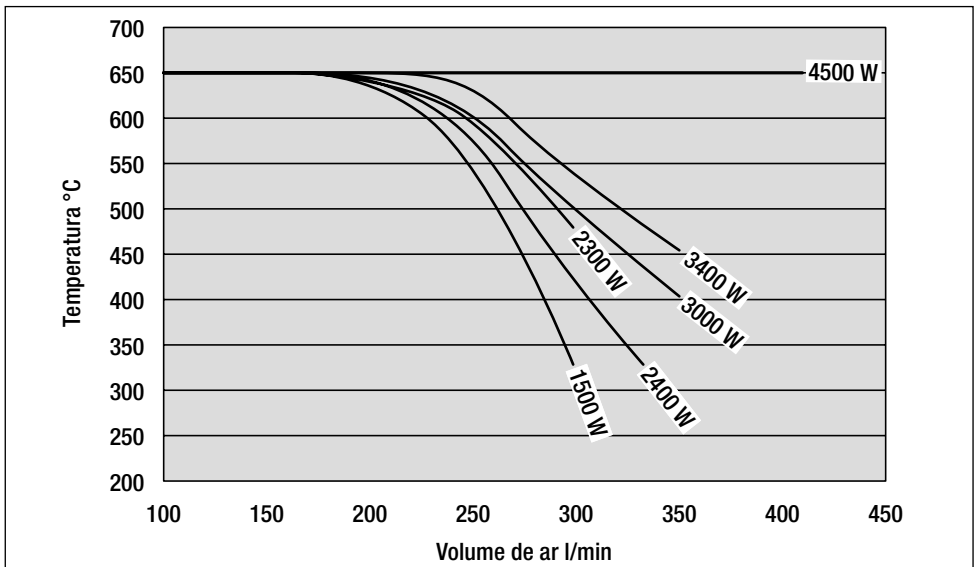

MISTRAL SYSTEM Interface / controle

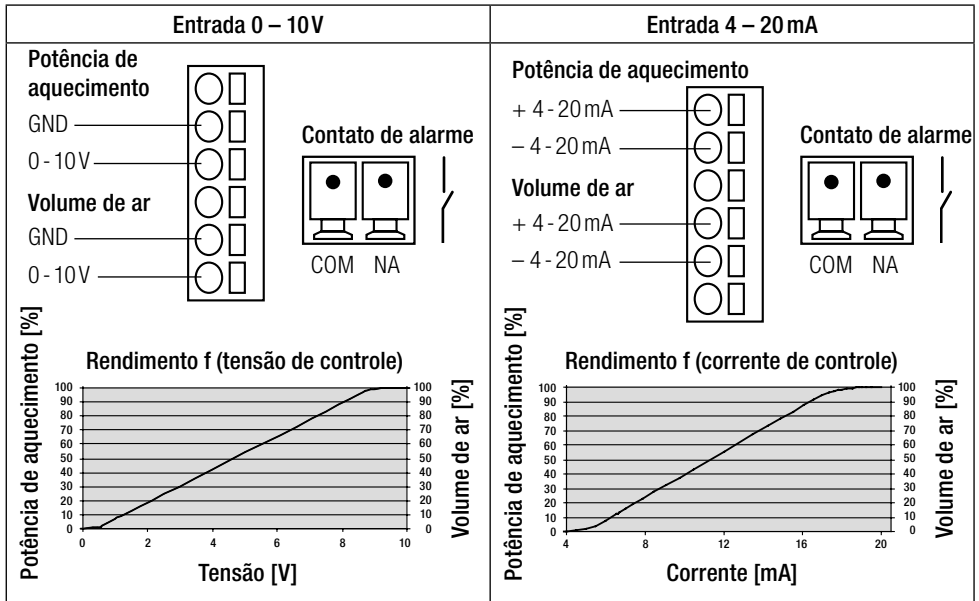

ATENÇÃO:

Em caso de utilização como aparelho de incorporação, na conexão à rede deve haver um dispositivo adequado para a desconexão de todos os polos da rede elétrica com uma distância de contato de no mínimo 3 mm.

Descrição do aparelho MISTRAL PREMIUM; SYSTEM

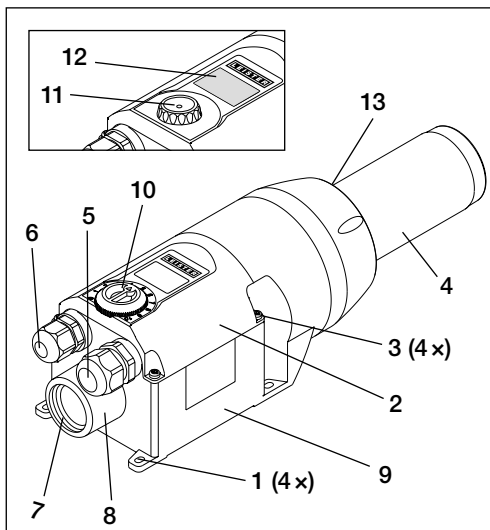

MISTRAL PREMIUM; SYSTEM

- 1 Abas de montagem
- 2 Tampa da caixa de conexões
- 3 Parafusos para caixa de conexões
- 4 Tubo do elemento de aquecimento
- 5 União roscada do cabo para conexão à rede
- 6 União roscada do cabo para interface
- 7 Flange de entrada de ar com rosca interna G 1"
- 8 Conexão \varnothing 38 para tubo de ar ou filtro de aço inoxidável
- 9 Caixa de conexões
- 13 Parafusos de fixação

MISTRAL PREMIUM

- 10 Potenciômetro para ajuste da potência de aquecimento

MISTRAL SYSTEM

- 11 e-drive para ajuste de temperatura/ar
- 12 Display

Preparação do MISTRAL PREMIUM; SYSTEM

- Retirar o MISTRAL da embalagem.
- Soltando os **parafusos (3)**, abrir a **tampa da caixa de conexões (2)**.
- Soltar a **união roscada do cabo para conexão à rede (5)**.
- Se necessário, soltar a **união roscada do cabo para interface (6)**.

Montagem

- O aparelho deve ser instalado somente por profissionais treinados.
- A temperatura ambiente não pode ser superior a 65 °C
- A montagem deve garantir que
 - seja fornecido apenas ar frio.
 - não seja gerado nenhum contrafluxo (quente).
 - nenhum jato de ar quente de outro equipamento passe através do aparelho.
- Proteger o MISTRAL contra vibrações e choques mecânicos.
- Fixar o MISTRAL com quatro parafusos Ø M4 nas **abas de montagem (1)**.
- Evitar o posicionamento vertical do aparelho. Se for obrigatória uma posição vertical, garantir o resfriamento do aparelho – **perigo de sobreaquecimento**.
- Dimensões de montagem, ver página 3 (tamanho)
- Em caso de ar com partículas de pó utilizar o filtro em aço inoxidável da Leister (ver acessórios) e deslocar para cima do **conexão ø 38 para tubo de ar ou filtro de aço inoxidável (8)**.
- Em caso de poeiras críticas (p.ex. poeiras metálicas, condutoras de electricidade ou húmidas) têm de ser usados filtros especiais para evitar curto-circuitos no aparelho.



As normas e diretrizes locais aplicáveis sempre devem ser observadas durante a instalação (por exemplo, diretrizes especiais de proteção contra incêndio, etc.).



Atenção: Operar o aparelho sempre com alimentação de ar!

Conexão

- O MISTRAL deve ser conectado por pessoal qualificado.
- Na conexão à rede, deve haver um dispositivo adequado para a desconexão de todos os polos da rede elétrica!
- Deve-se assegurar de que os cabos de conexão não toquem no tubo do elemento de aquecimento e não estejam expostos ao jato de ar quente.
- O aparelho deve ser conectado de acordo com o esquema de conexões e a disposição dos bornes nas páginas 4, 5, 6 (circuito elétrico) do manual de instruções:
 - Executar a fiação na **caixa de conexões (9)**.
- **ATENÇÃO:** No MISTRAL PREMIUM, verificar as configurações do interruptor de codificação (ver circuito elétrico na página 4 ou 5).
- Apertar a **união roscada do cabo para conexão à rede (5)** e **união roscada do cabo para interface (6)**.
- Montar a **tampa da caixa de conexões (2)** com os **parafusos (3)**.
- Conectar o MISTRAL à rede elétrica.
- Segundo as necessidades, empurrar o bico correspondente ou refletor sobre o **tubo do elemento de aquecimento (4)**.
- É necessário assegurar para que o ar quente possa fluir livremente, caso contrário o aparelho pode ser danificado devido ao contrafluxo quente (perigo de fogo!).
- Ligar a rede elétrica.
- Ajustar a potência desejada de aquecimento do MISTRAL PREMIUM com o **potenciômetro (10)**.
- Ajustar o MISTRAL PREMIUM com o **potenciômetro (10)** para o nível 0 e, assim, deixá-lo resfriar.
- Após a operação de aquecimento, deixar o MISTRAL SYSTEM resfriar.
- As informações na tabela a seguir são relevantes apenas para a América do Norte. A certificação UL será anulada se um cabo de conexão incorreto for usado:

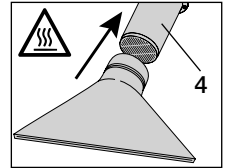

Corrente nominal	≤ 10A	≤ 12A	≤ 13A	≤ 16A	≤ 18A	≤ 21A	≤ 25A
Seção transversal mínima	18AWG	17AWG	16AWG	15AWG	14AWG	13AWG	12AWG

Substituição de bico / refletor













Perigo de queimadura! Não tocar no tubo do elemento de aquecimento e no bico se eles estiverem quentes. Ao substituir o bico ou o refletor, deixar o aparelho resfriar antes.





Antes de abrir a caixa externa do potenciômetro, todos os polos do aparelho devem ser desconectados da rede elétrica.

Descrição do display do MISTRAL SYSTEM

Símbolos	Símbolos
 Elemento de aquecimento com defeito	 Entrar em contato com o serviço de assistência Leister
 Proteção do aparelho ativada (superaquecimento do elemento de aquecimento/da proteção do aparelho)	 Processo de resfriamento
 Subtensão	 Stand-by
 Aumentar temperatura	 Reduzir temperatura
 Ventilador ativo	 Campo do indicador para representação de unidades ou informações para o menu de serviço
 Campo de valores para representação dos valores nominais e reais. Trata-se de um display de segmentos de 4 dígitos sem ponto decimal	

O gráfico de barras simboliza a velocidade de rotação do ventilador em 5 níveis. Ao mesmo tempo aparece a exibição em % (1P–100P)

 Velocidade de rotação do ventilador 100% máx.

 Velocidade de rotação do ventilador 1% mín.

Substituição do elemento de aquecimento



A substituição do elemento de aquecimento pode ser realizado somente por **profissionais treinados** sob supervisão deles.

- ❶ Deixar o aparelho resfriar. MISTRAL System desliga automaticamente.
- ❷ Desconectar o aparelho da rede elétrica.
- ❸ Retirar os quatro **parafusos de fixação (13)**.
- ❹ **Retirar o tubo do elemento de aquecimento (4)**, o tubo de mica, a vedação e o elemento de aquecimento.
- ❺ Tirar o elemento de aquecimento da embalagem.
- ❻ Empurrar o elemento de aquecimento, a vedação, o tubo de mica e o **tubo do elemento de aquecimento (4)**.
- ❼ **Montar o tubo do elemento de aquecimento (4)** com quatro **parafusos de fixação (13)**.
- ❽ Conectar o aparelho à rede elétrica. A tensão nominal, que está especificada no aparelho, deve coincidir com a tensão da rede.

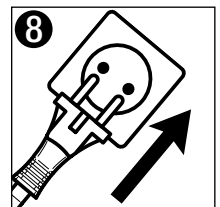
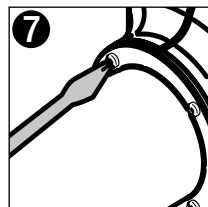
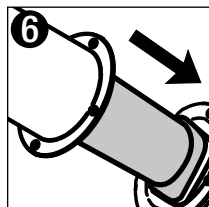
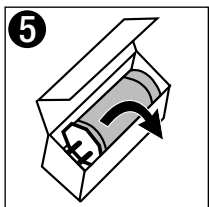
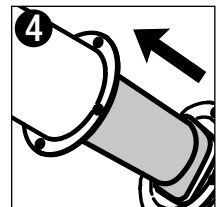
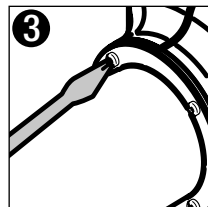
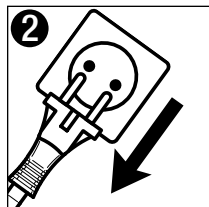
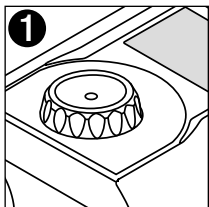

Função da proteção do elemento de aquecimento e do aparelho

Se o elemento de aquecimento ou o aparelho superaquecer (temperatura de entrada do ar muito elevada ou contrafluxo quente), a entrada de energia ao elemento de aquecimento é interrompida. No MISTRAL SYSTEM o contato de trabalho do relé de alarme é simultaneamente aberto. Se a proteção do elemento de aquecimento ou a proteção do aparelho atuar, por razões de segurança devem ser seguidas as seguintes etapas para o restabelecimento do aparelho.

PREMIUM	SYSTEM
A Desligar a potência de aquecimento (ajustar o potenciômetro (10) para 0)	A Deixar o aparelho resfriar
B Deixar o aparelho resfriar	B Desconectar o aparelho da rede elétrica
	C Reconectar o aparelho à rede elétrica após 10 segundos.
D Verificar os orifícios de entrada e saída de ar e, se necessário, limpar.	

Definição de bico do orifício de saída de ar

MISTRAL SYSTEM (tubo do elemento de aquecimento \varnothing 36,5 mm)

Ajuste do bico	Tipo de bico	Nº artigo	Orifício de saída de ar (mm ²)
Load 0	-	-	380
Load 1	Bico de fenda larga	108.078	400
Load 2	Bico de fenda larga	107.261	280

Definição de bico do orifício de saída de ar



MISTRAL SYSTEM (tubo do elemento de aquecimento \varnothing 50 mm)

Ajuste do bico	Tipo de bico	Nº artigo	Orifício de saída de ar (mm ²)
Load 0	-	-	706
Load 1	Bico de fenda larga	105.961	540
Load 2	Bico de fenda larga	106.057	400

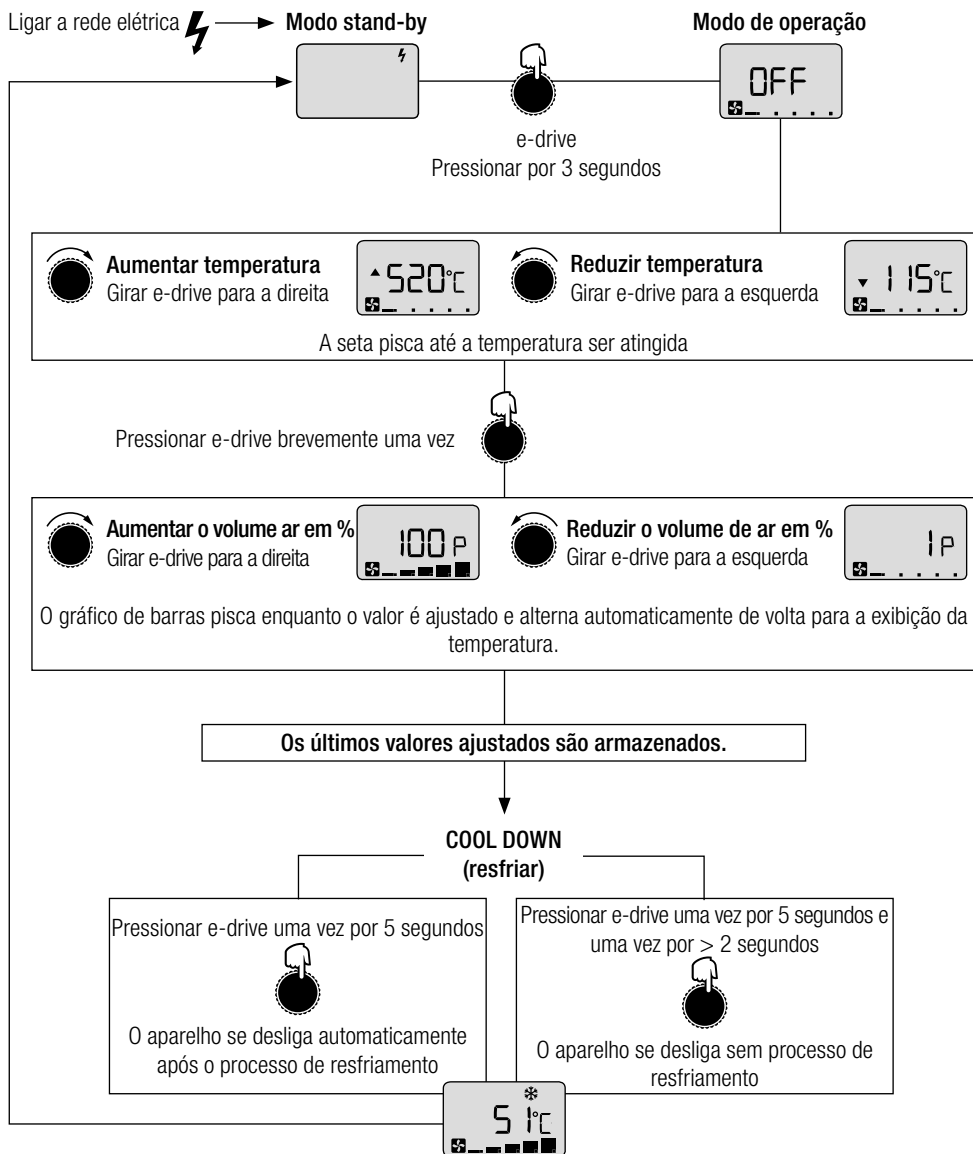
Operação do MISTRAL SYSTEM



Definição do menu de configuração do MISTRAL SYSTEM

e-drive	Função	e-drive	Função
	pressionar brevemente uma vez = ativar		girar para a direita
	pressionar por 3 segundos = confirmar		girar para a esquerda



Observação:

Se o e-drive for pressionado brevemente uma vez sem confirmar, os valores não serão armazenados.

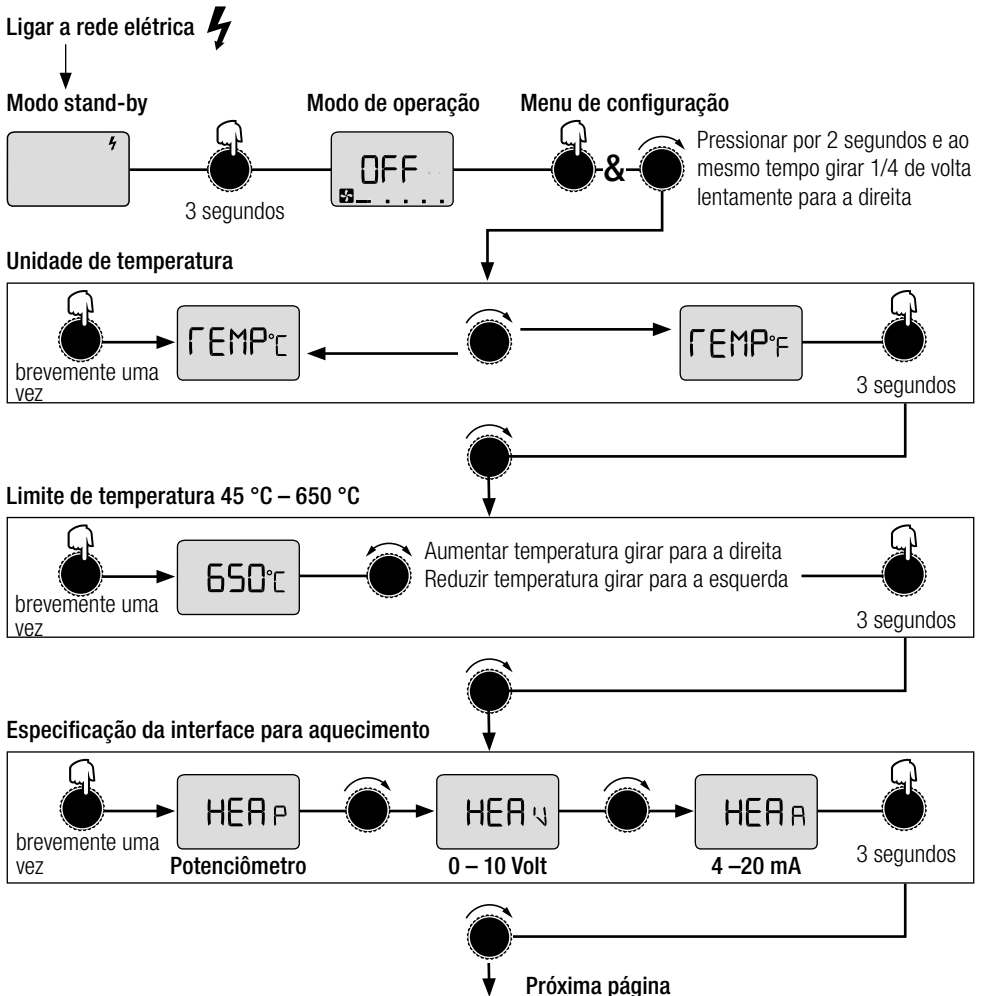

Definição do menu de configuração do MISTRAL SYSTEM

Especificação da interface do ventilador

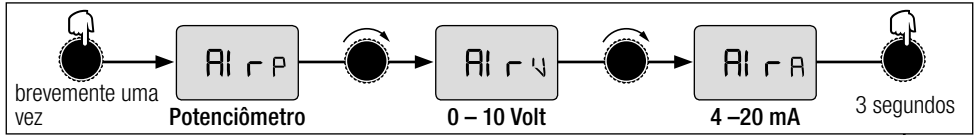

Controlado ou regulado

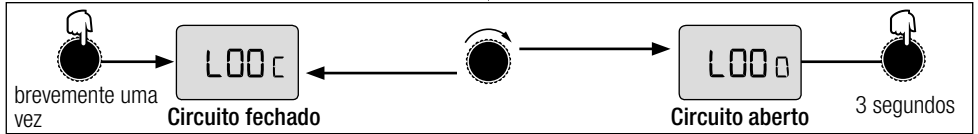

Ajuste do bico (ver tabela)

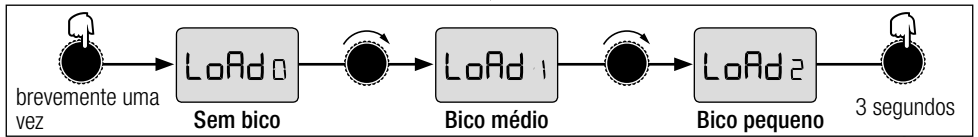

Deslocamento de temperatura +40 °C / -40 °C ajustável

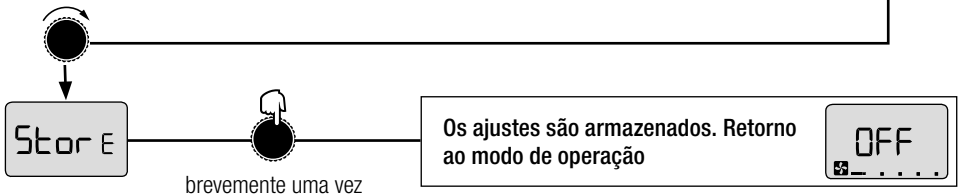
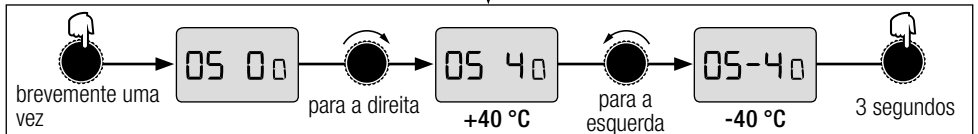

Exibição Descrição

TEMP°C	Temperatura graus Celsius
TEMP°F	Temperatura graus Fahrenheit
HEA P	Aquecimento e-drive (potenciômetro)
HEA V	Especificação da interface para aquecimento 0-10 V
HEA A	Especificação da interface para aquecimento 4-20 mA
Al r P	Ventilador e-drive (potenciômetro)
Al r V	Especificação da interface para ventilador 0-10 V

Exibição Descrição

Al r A	Especificação da interface para ventilador 4-20 mA
L00 C	Circuito fechado regulado
L00 □	Circuito aberto controlado
LoAd □	Parâmetro de regulagem sem bico
LoAd 1	Parâmetro de regulagem bico médio
LoAd 2	Parâmetro de regulagem bico pequeno
05 -4	Ajuste do deslocamento da temperatura +/- 40 °C
Stor E	Salvar

Mensagens de erro

Indicação	Designação	Causa do erro	Solução do erro
E001 c	Termoelemento	Conexão do termoelemento	Controlar a conexão do termoelemento
		Termoelemento com defeito	Entrar em contato com o serviço de assistência Leister
* E002 c	Temperatura do elemento de aquecimento muito alta	Elemento de aquecimento com defeito	Substituir elemento de aquecimento (pág. 14)
		Entrada de ar bloqueada	Verificar entrada de ar
		Filtro de aço inoxidável bloqueado	Limpar filtro de aço inoxidável
		Saída de ar bloqueada	Verificar saída de ar
		Bico incorreto montado	Substituir bico
		Definição incorreta do bico	Verificar a definição do bico (pág. 15)
E005 c	Subtensão	Tensão da rede < 20% da tensão nominal	Verificar a tensão da rede
		Aparelho com defeito	Entrar em contato com o serviço de assistência Leister
E008 c	Temperatura do aparelho muito alta	Temperatura ambiente maior que a especificada	Reduzir a temperatura ambiente
		Temperatura de entrada de ar maior que a especificada	Reduzir a temperatura de entrada de ar
		Entrada de ar bloqueada	Verificar entrada de ar
		Filtro de aço inoxidável bloqueado	Limpar filtro de aço inoxidável
		Saída de ar bloqueada	Verificar saída de ar
		Bico incorreto montado	Substituir bico
		Definição incorreta do bico	Verificar a definição do bico (pág. 15)
E003 c	Entrar em contato com o serviço de assistência Leister		
E004 c			
E006 c			
E007 c			
E009 c			

Formação

- Leister Technologies AG e os seus pontos de assistência autorizados oferecem cursos de soldadura e formações gratuitamente. Informações em www.leister.com.

Desenhos 3D

Desenhos 3D estão disponíveis no seu ponto de assistência ou em www.leister.com.

Acessórios

- Podem ser utilizados somente acessórios Leister.
- A Leister oferece uma ampla gama de acessórios, por exemplo,
 - Regulador de temperatura
 - Bicos
 - Refletores
 - Potenciômetro externo
 - Filtro
- Acessórios em www.leister.com

Assistência e reparação

- As reparações devem ser efectuadas por **pontos de assistência Leister** autorizados. Estes garantem dentro do prazo útil um **serviço de reparação** especializado e fiável com peças de substituição originais de acordo com os esquemas eléctricos e listas de peças de substituição.

Garantia legal

- A princípio oferecemos para este aparelho uma garantia conforme as disposições legais/específicas de cada país a partir da data de compra (comprovada pela factura ou guia de remessa). Danos que surgem são eliminados através de fornecimento de reposição ou reparação. Elementos de aquecimento são excluídos desta garantia.
- Prescrições legais reservadas excluem outros direitos.
- Danos causados por desgaste natural, sobrecarga ou tratamento incorrecto, são excluídos da garantia.
- Aparelhos que foram alterados pelo comprador não têm direito à garantia.

Instruções de segurança UL



Dupla isolamento - para os serviços de manutenção, use apenas peças de reposição idênticas.
Cuidado: Desconecte da fonte de alimentação antes de abrir esta tampa.



PLASTIC WELDING PRODUCTS | INDUSTRIAL HEATING & LASER SYSTEMS

Leister Technologies AG | Galileo-Strasse 10 | 6056 Kägiswil | Switzerland
phone: +41 41 662 74 74 | leister@leister.com | www.leister.com | www.weldy.com

Declaration of incorporation

(in terms of the EC machinery directive 2006/42/EC; Appendix II B)

Leister Technologies AG

Galileo-Strasse 10, CH-6056 Kaegiswil/Switzerland

hereby declares the partly completed machinery

Designation	Hot Air Blower
Type	Mistral Premium, Mistral System
Option	-

- as far as it is possible from the scope of supply – fulfills the applicable essential requirements of the EC machinery directive (2006/42/EC).

The partly completed machinery furthermore complies with the provisions of the following EC directive(s):

EC directive(s)	2014/30/EU (EMC Directive)
	2014/35/EU (Low Voltage Directive)
	2011/65/EU (RoHS Directive)

Harmonised standards	EN ISO 12100
	EN 55014-1, EN 55014-2, EN 61000-6-2, EN 61000-3-2
	EN 61000-3-3, EN 61000-3-11 (Zmax), EN 61000-3-12
	EN 62233, EN 60335-2-45
	EN 50581

In addition, we declare the relevant technical documentation for this partly completed machinery is compiled in accordance with Annex VII (part B) and will be electronically transmitted to national authorities in response to a reasoned request.

Authorised documentation representative: Thomas Schäfer, Manager Product Conformity

The partly completed machine must not be put into service until the final machinery into which it is to be incorporated has been declared in conformity with the provisions of the EC machinery directive (2006/42/EC), where appropriate.

Kaegiswil, 06.05.2019

Bruno von Wyl
(Chief Technical Officer)

Christoph Baumgartner
(General Manager)



Your authorised Service Centre is:

A large, empty rectangular box with a thin black border, intended for the user to write the name and address of their authorized service center.

Leister Technologies AG
Galileo-Strasse 10
CH-6056 Kaegiswil/Switzerland
Tel. +41 41 662 74 74
Fax +41 41 662 74 16
www.leister.com
sales@leister.com