



IGNITER BM4 / BR4 Ignition Blower

The IGNITER ignition blower from Leister has been specially designed for easy installation into pellet and wood chip stoves.

- Heating element protection with phototransistor and device protection via temperature protection circuit
- Connector plug located directly on the tool means easy removal and installation
- New assembly support for positioning in furnace
- Connection adapter for air hose includes inner G1" thread, 38 mm external push-fit connection
- Available with pipe joint adapter with M14 thread for easy adaption of the heat conduction lines and extensions (available only for IGNITER BM4)



Technical Data

Model		BM4	BM4	BM4	BM4	BM4	BR4
Voltage	V	120	120	230	230	230	230
Power consumption	W	1100	1550	600	1100	1600	3400
Min. air volume	l/min	230	230	80	230	230	360
Air pressure	kPa	2.48	2.48	0.3	2.48	2.48	4.00
Max. temperature	°C	600	600	500	600	600	650
Noise level	dB (A)	68	68	58	68	68	68
Heating tube dia.	mm	31.5	31.5	31.5	31.5	31.5	50
Size (L x W)	mm	283 x Ø90	283 x Ø90	283 x Ø90	283 x Ø90	283 x Ø90	294 x Ø90
Weight	kg	1.0	1.0	1.0	1.0	1.0	1.2
Approval markings		CE, cURus	CE, cURus	CE, cURus	CE, cURus	CE, cURus	CE
Electrical protection		Class II	Class II	Class II	Class II	Class II	Class II

Article No.:

Note: Plug for cable connection and cable are not included. See accessories for part numbers.

141.882: IGNITER BM4 120V / 1100W

141.881: IGNITER BM4 120V / 1550W

139.232: IGNITER BM4 230V / 600W

140.711: IGNITER BM4 230V / 1100W

144.012: IGNITER BM4 230V / 1100W with M14 screw adapter







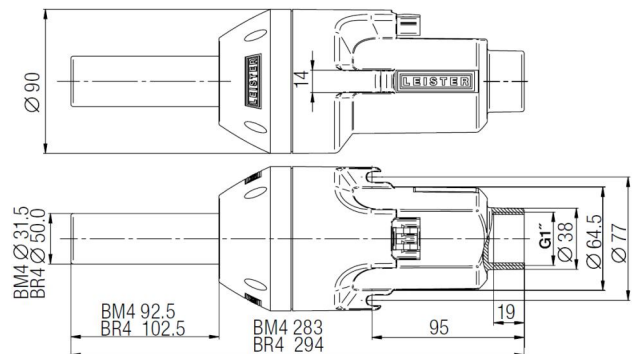

139.231: IGNITER BM4 230V / 1600W

146.296: IGNITER BR4 230V / 3400W

Installation dimensions in mm



IGNITER Accessories

 <p>156.094: Heater tube Ø31.5 mm, M14 (BM4 only)</p>	 <p>156.095: Heater tube Ø31.5 mm, G3/8" (BM4 only)</p>	 <p>142.976: Plug (WAGO) with strain relief</p>	 <p>142.967: Power supply cord 3 m (Wago), 3 x 1 mm², w/o plug</p>	 <p>143.131: Power supply cord 3 m (Wago) S, 3 x 1 mm², w/o plug</p>	 <p>153.245: Stainless steel filter</p>
 <p>107.286: Air hose Ø38 mm, PVC</p>	 <p>107.287: Hose clip Ø38/60 mm</p>				